



FOREST CRS® DESIGN SERIES



MANUAL
CONTROL

The design line of the curtain rod is characterised by sleek, sharp lines. These curtain rods combine aesthetic design with functionality, providing a modern and contemporary look.

CRS® SQUARE 30
CRS® RECTANGULAR 45

THE WORLD
BEHIND
YOUR
CURTAINS

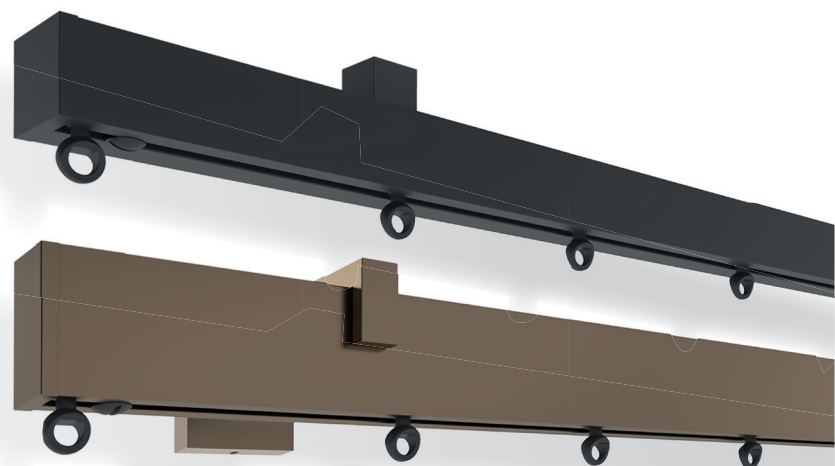

FOREST CRS® SQUARE 30



The square manual design curtain rod features a sleek, compact shape that fits perfectly in modern interiors. Thanks to various mounting options, you can create a unique look ranging from Scandinavian to industrial. Available in five trendy colours, including a matt finish, this curtain rod offers the perfect combination of style and functionality.

PRODUCT INFORMATION

- Smooth and silent operation
- Curtain railrod equipped with carriers
- Choice of various brackets in matching colours, including a double bracket
- Easy and quick to install
- Compatible with the Forest Wave system (FES)
- Unique 10-year warranty

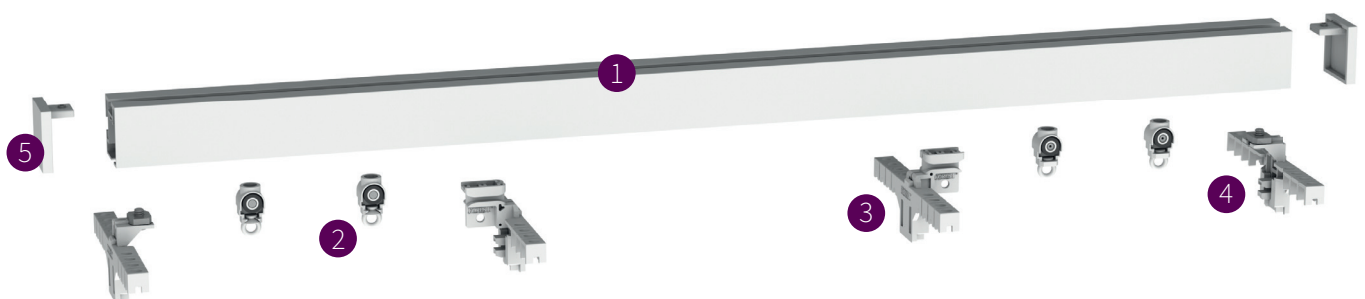

- 1 CRS Square 30
- 2 Roller Carrier Easywave (also available with cord)
- 3 Adjustable Wave Master Carrier
- 4 Adjustable Wave Endstop
- 5 Finial



COLOUR OPTIONS



MOUNTING BRACKETS

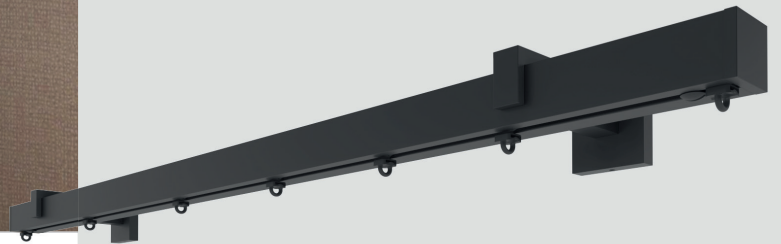

Top fix wall bracket



Back fix wall bracket

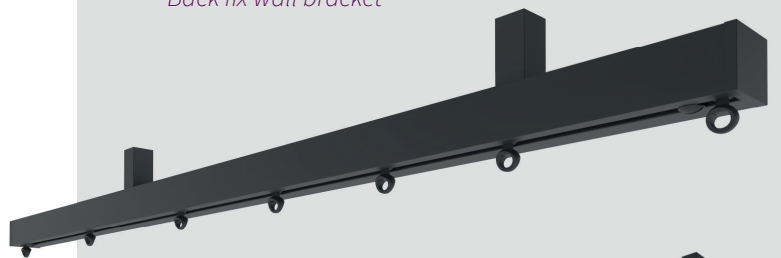

Ceiling bracket

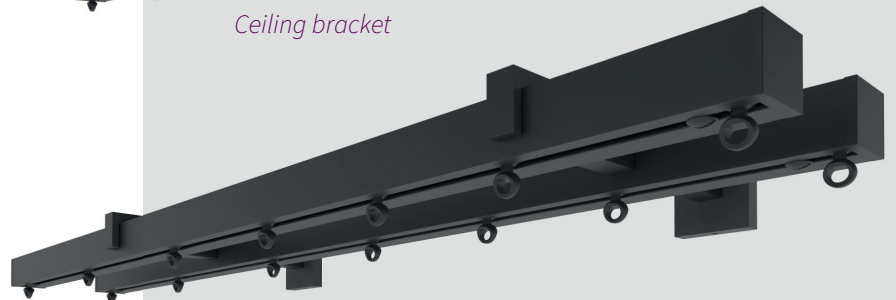

Top fix twin wall bracket

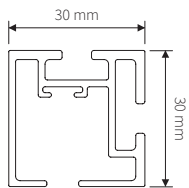

FEATURES

- Dimensions 30x30 mm
- High-quality aluminum extrusion: Aluminum Billet (6060)
- Powder coating standard: Qualicoat Class 1 & GSB Florida 1
- Weight: 637 grams per meter
- Maximum length in one piece: 5.80 meters
- Option to extend the rail

FOR USE IN

Hotels - shops - offices - homes, or wherever a high-quality, hand-operated design curtain rod system is desired.

FOREST CRS® SQUARE 30

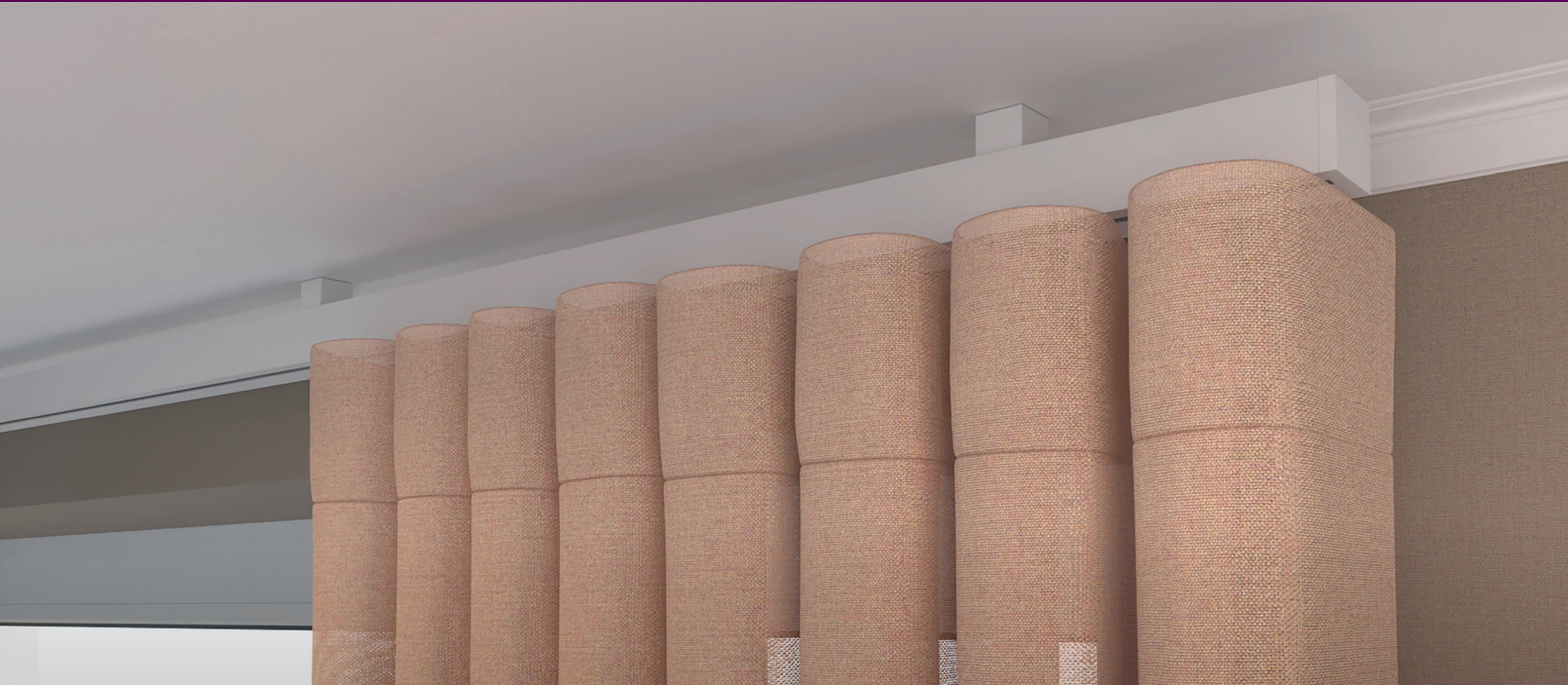

APPLICATIONS

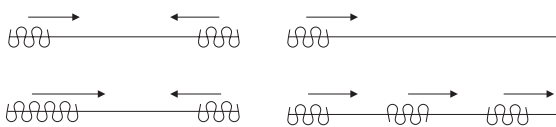

CUTTING INFORMATION

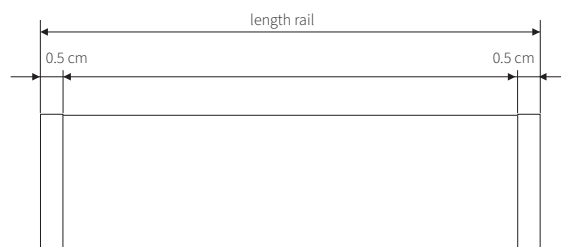

CARRIER MEASUREMENTS

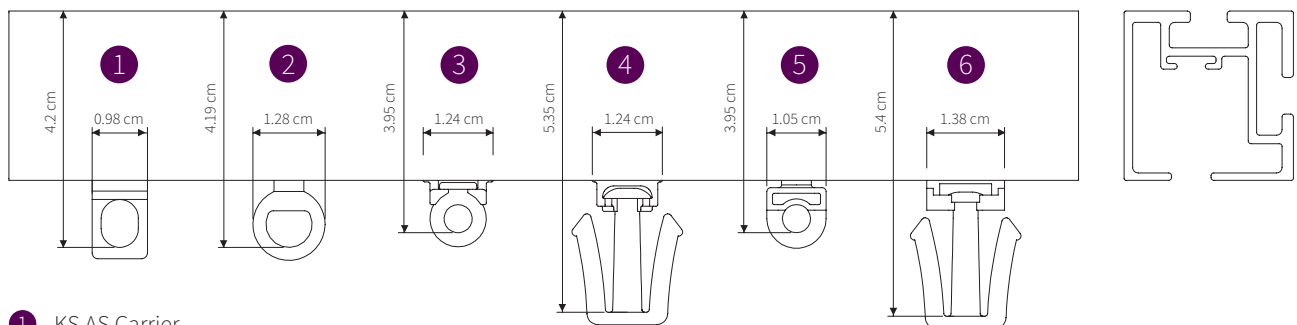

- ① KS AS Carrier
- ② CRS Carrier round
- ③ Contract Roller
- ④ Contract Easyfold base roller with Easyflex hook
- ⑤ Square Easywave carrier
- ⑥ FES Easyfold basic with Easyflex hook



MOUNTING OPTIONS

1.8 cm ceiling bracket universal

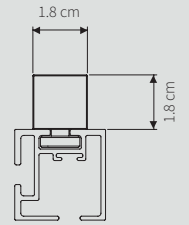

4.0 cm ceiling bracket universal

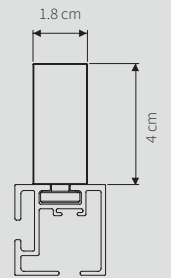

MASTER CARRIER OPTIONS

Easyflex Master Carrier 90 degrees left/right

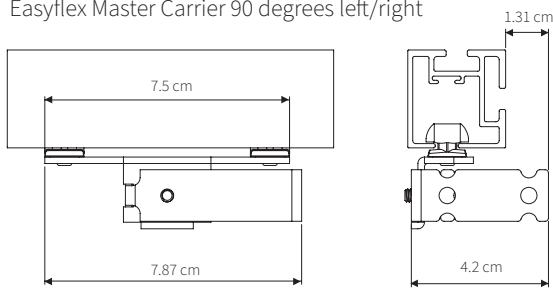

Wave Adjustable Master Carrier

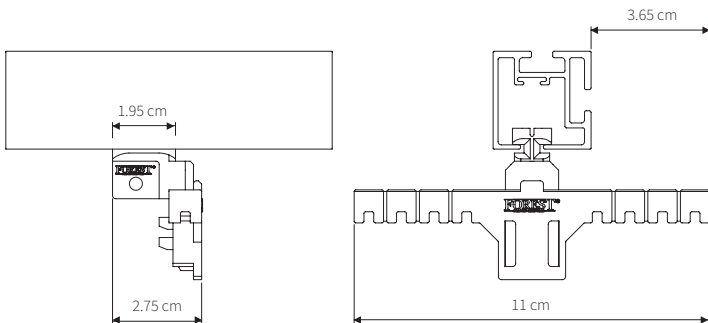

8.0 cm wall bracket universal (back fix)

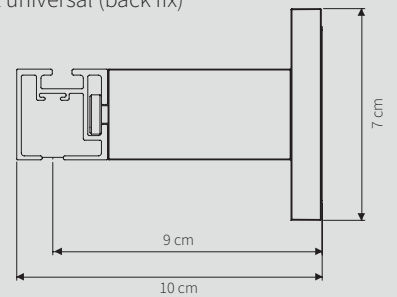

8.0 cm wall bracket square (top fix)

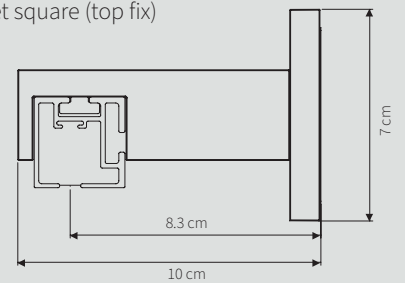

16 cm / 20 cm double wall bracket square (top fix)

- 16 cm: A) 18.0 cm B) 8.0 cm C) 8.0 cm
 20 cm: A) 21.4 cm B) 7.7 cm C) 12.0 cm

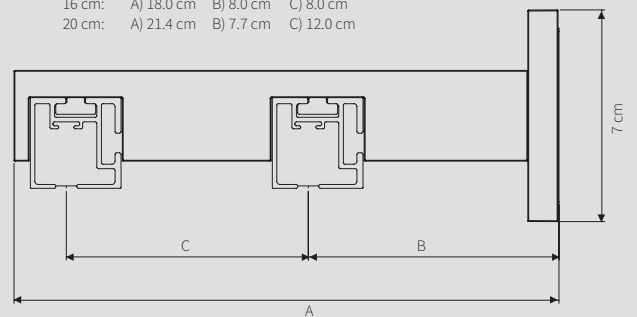

FOREST CRS® RECTANGULAR 45



The rectangular manual design curtain rod has a sleek, elegant shape that fits perfectly in modern interiors. Thanks to the various mounting options, you can create a unique look ranging from Scandinavian to industrial. Available in five trendy colours, including a matt finish, this curtain rod offers the perfect combination of style and functionality.

PRODUCT INFORMATION

- Operates smoothly and silently
- Curtain railrod equipped with carriers
- Choice of various brackets in matching colours, including a double wall bracket
- Easy and quick to install
- Compatible with the Forest Wave system (FES)
- Unique 10-year warranty

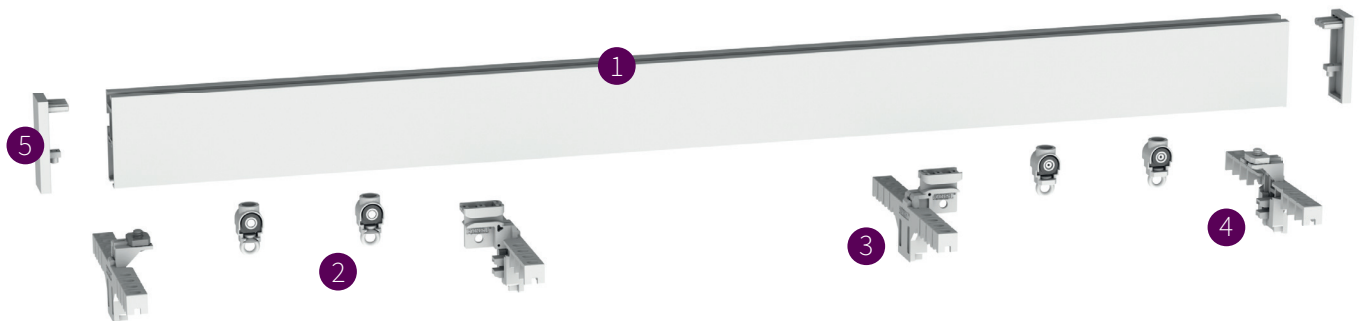

- 1 CRS Rectangular 45
- 2 Roller Carrier Easywave (also available with cord)
- 3 Adjustable Wave Master Carrier
- 4 Adjustable Wave Endstop
- 5 Finial



COLOUR OPTIONS



Matt white



Stone grey



Taupe



Antique



Matt black

MOUNTING BRACKETS

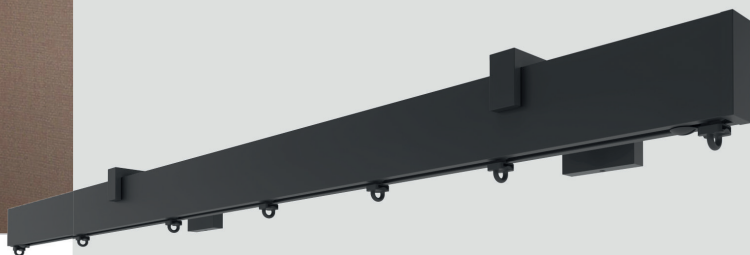

Top fix wall bracket



Back fix wall bracket



Ceiling bracket

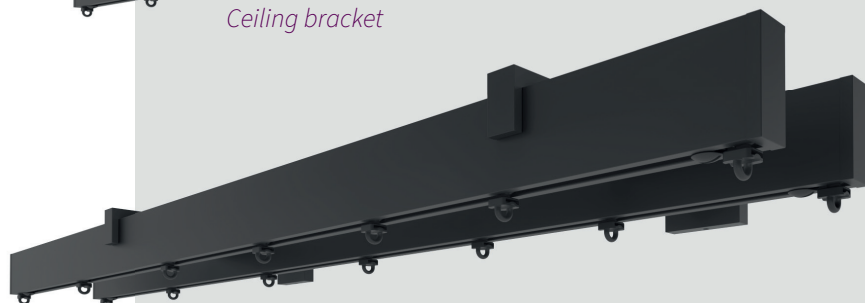

Top fix twin wall bracket

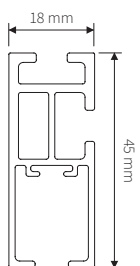

FEATURES

- Dimensions 45x18 mm
- High-quality aluminum extrusion: Aluminum Billet (6060)
- Powder coating standard: Qualicoat Class 1 & GSB Florida 1
- Weight: 632 grams per meter
- Maximum length in one piece: 5.80 meters
- Option to extend the rail

FOR USE IN

Hotels - shops - offices - homes, or wherever a high-quality, hand-operated design curtain rod system is desired.

FOREST CRS® RECTANGULAR 45

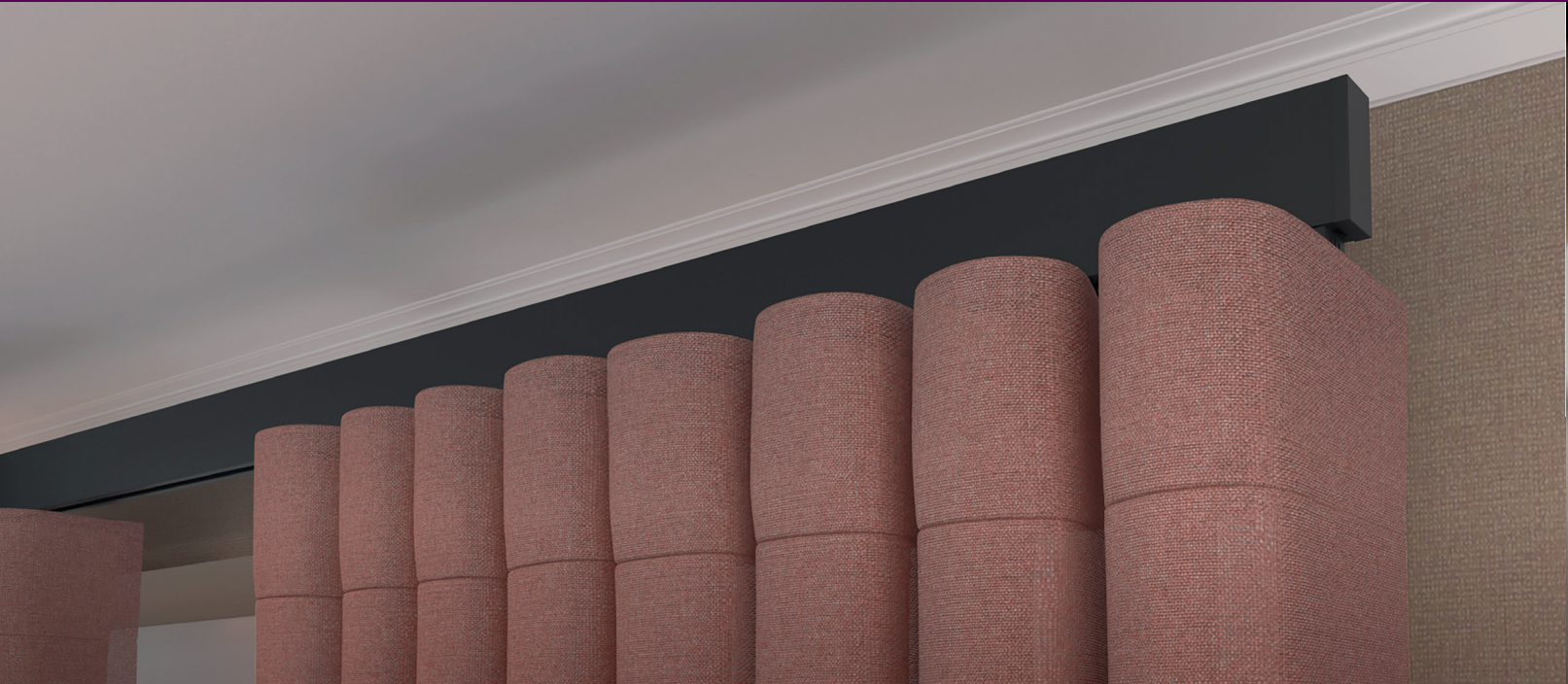

APPLICATIONS

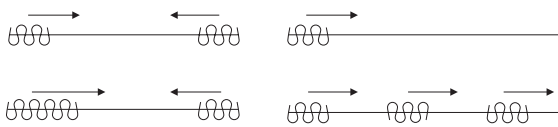

CUTTING INFORMATION

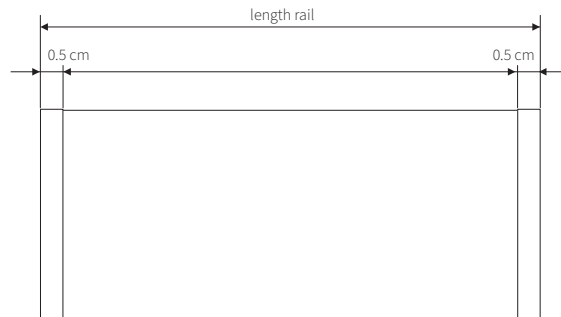

CARRIER MEASUREMENTS

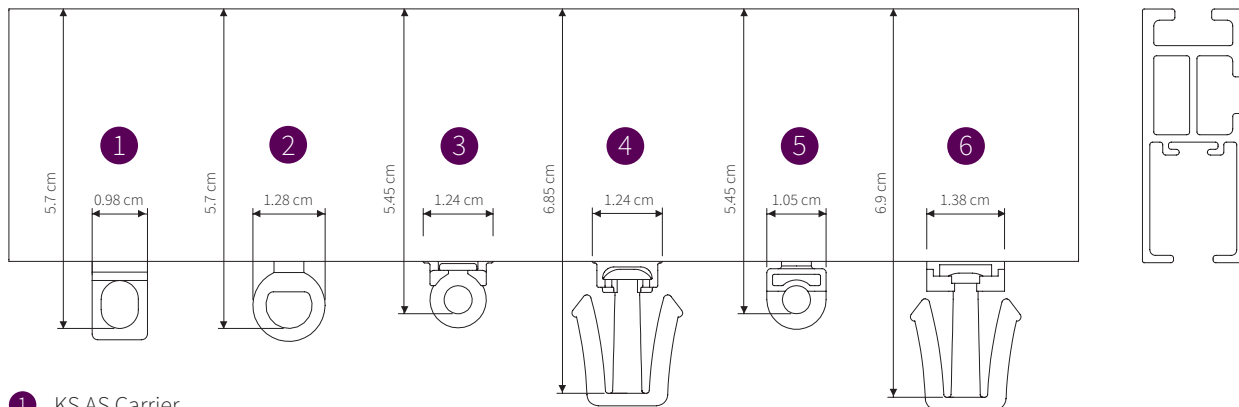

- ① KSAS Carrier
- ② CRS Carrier round
- ③ Contract Roller
- ④ Contract Easyfold base roller with Easyflex hook
- ⑤ Square Easywave carrier
- ⑥ FES Easyfold basic with Easyflex hook



MOUNTING OPTIONS

1.8 cm ceiling bracket universal

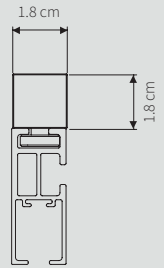

4.0 cm ceiling bracket universal

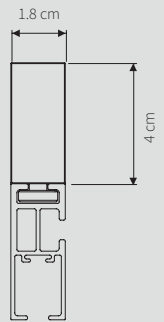

MASTER CARRIER OPTIONS

Easyflex Master Carrier 90 degrees left/right

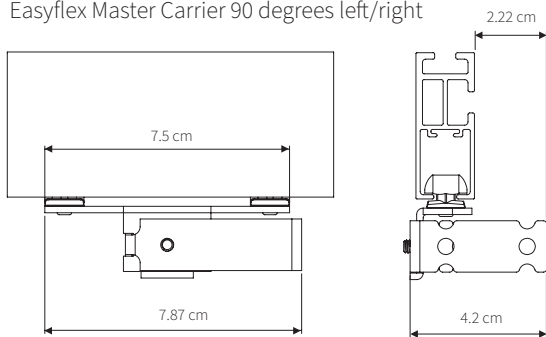

Wave Adjustable Master Carrier

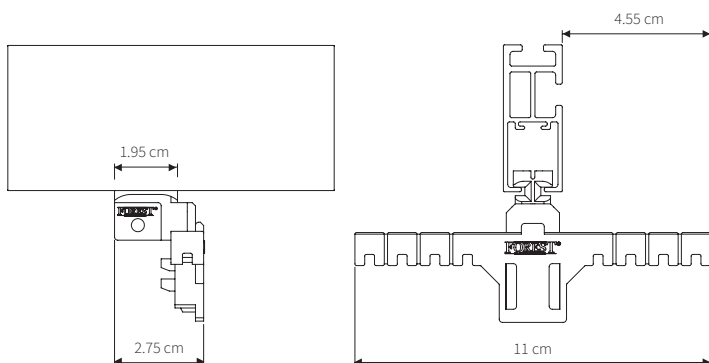

8.0 cm wall bracket universal (back fix)

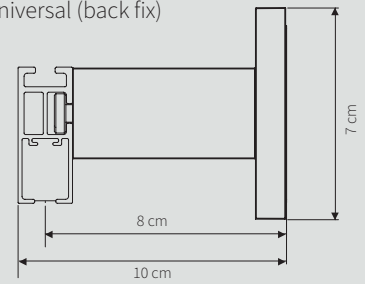

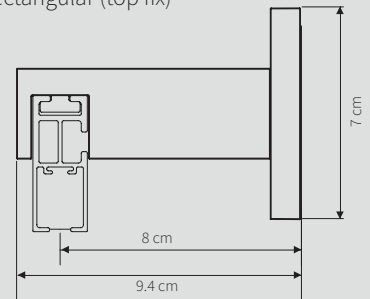

8.0 cm wall bracket rectangular (top fix)





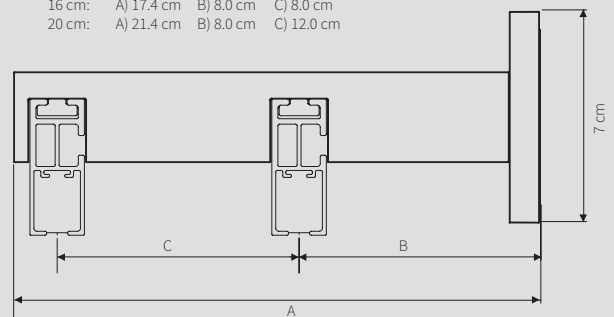

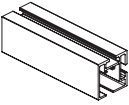
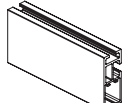
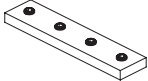
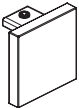

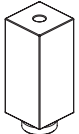
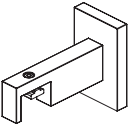
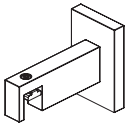
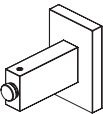
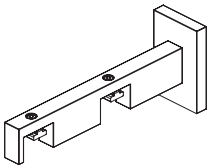
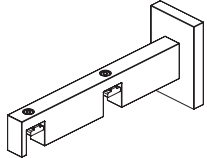

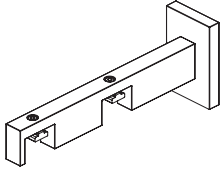
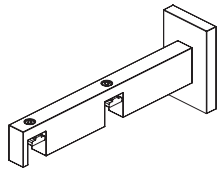
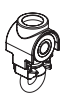

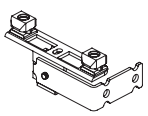
16 cm / 20 cm double wall bracket rectangular (back fix)

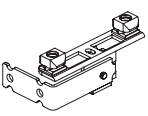
16 cm: A) 17.4 cm B) 8.0 cm C) 8.0 cm
20 cm: A) 21.4 cm B) 8.0 cm C) 12.0 cm

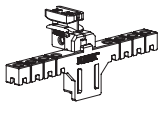
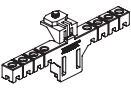

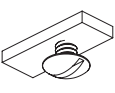
CRS SQUARE 30	CRS RECTANGULAR 45	ARTICLE	PACKING UNIT		ART.NR
•		 CRS SQUARE 30	5.80 mtr/tube	matt white stone grey taupe matt black antique	6201301580-M 6201303580 6201304580 6201306580-M 6201309580
	•	 CRS RECTANGULAR 45	5.80 mtr/tube	matt white stone grey taupe matt black antique	6201451580-M 6201453580 6201454580 6201456580-M 6201459580
•	•	 CRS RECTANGULAR 45/SQUARE 30 RAILCONNECTOR	25/box	steel	6215103045
•		 CRS SQUARE 30 FINIAL METAL	10/box	matt white stone grey taupe matt black antique	6216101030-M 6216103030 6216104030 6216106030-M 6216109030
	•	 CRS RECTANGULAR 45 FINIAL METAL	10/box	matt white stone grey taupe matt black antique	6216101045-M 6216103045 6216104045 6216106045-M 6216109045
•	•	 CRS RECTANGULAR 45/SQUARE 30 CEILING BRACKET 1.8 CM	4/box	matt white stone grey taupe matt black antique	6218013045-M 6218033045 6218043045 6218063045-M 6218093045
•	•	 CRS RECTANGULAR 45/SQUARE 30 CEILING BRACKET 4 CM	4/box	matt white stone grey taupe matt black antique	6219013045-M 6219033045 6219043045 6219063045-M 6219093045
•		 CRS SQUARE 30 WALL BRACKET 8 CM Top fix	2/box	matt white stone grey taupe matt black antique	6220080130-M 6220080330 6220080430 6220080630-M 6220080930
	•	 CRS RECTANGULAR 45 WALL BRACKET 8 CM Top fix	2/box	matt white stone grey taupe matt black antique	6220080145-M 6220080345 6220080445 6220080645-M 6220080945
•	•	 CRS RECTANGULAR 45/SQUARE 30 WALL-/CEILING BRACKET 8 CM Back fix	2/box	matt white stone grey taupe matt black antique	6221013045-M 6221033045 6221043045 6221063045-M 6221093045
•		 CRS SQUARE 30 WALL BRACKET DOUBLE 16 CM Top fix	2/box	matt white stone grey taupe matt black antique	6222160130-M 6222160330 6222160430 6222160630-M 6222160930
	•	 CRS RECTANGULAR 45 WALL BRACKET DOUBLE 16 CM Top fix	2/box	matt white stone grey taupe matt black antique	6222160145-M 6222160345 6222160445 6222160645-M 6222160945

CRS SQUARE 30	CRS RECTANGULAR 45	ARTICLE	PACKING UNIT	ART.NR
•		 <p>CRS SQUARE 30 WALL BRACKET DOUBLE 20CM Top fix</p>	100/box	matt white stone grey taupe matt black antique 6222200130-M 6222200330 6222200430 6222200630-M 6222200930
	•	 <p>CRS RECTANGULAR 45 WALL BRACKET DOUBLE 20CM Top fix</p>	100/box	matt white stone grey taupe matt black antique 6222200145-M 6222200345 6222200445 6222200645-M 6222200945
•	•	 <p>CONTRACT ROLLER CARRIER For a silent and smoothly operation with heavier curtains. Suitable for standard pleat.</p>	100/box	white black 4831001000 4831006000
•	•	 <p>KS AS CARRIER "Klickable", offset, constructed of UV-resistant plastic. 10 Carriers on a break-away strip. Can be clicked in after installation. Suitable for standard pleat.</p>	500/box	white grey black 1010001000 1010003000 1010006000
•	•	 <p>CRS CARRIER ROUND Suitable for standard pleat. Rotatable.</p>	500/box	white black 5810101000 5810106000
•	•	 <p>EASYFLEX MASTER CARRIER LEFT For use with wave pleat curtains (Easyflex) For center draw. Suitable for wave.</p>	25/box	white black 4815351090 4815356090
		90 degrees left for small stiffener		white 4815361090
•	•	 <p>EASYFLEX MASTER CARRIER RIGHT For use with wave pleat curtains (Easyflex) Center draw. Suitable for wave.</p>	25/box	white black 4815451090 4815456090
		90 degrees right for small stiffener		white 4815461090
•	•	 <p>WAVE ADJUSTABLE MASTER CARRIER For use with wave pleat curtains (Easyflex). Adjustable in height with detachable blocks to achieve the desired wave pleat depth.</p>	25/box	white black 4813001050 4813006050
•	•	 <p>WAVE ADJUSTABLE ENDSTOP For use with wave pleat curtains (Easyflex). Adjustable in height with detachable blocks to achieve the desired wave pleat depth.</p>	25/box	white black 4816001001 4816006001
	•	 <p>ENDSTOP UNIVERSAL METAL</p>	100/box	matt white stone grey matt black 8880001000 8880003000-V2 8880006000
•		 <p>CRS SQUARE 30 ENDSTOP</p>	100/box	matt white matt black 6201301000 6201306000
•	•	 <p>FOREST ROD COLOUR COLLECTION BOX</p>	1/box	9905000000

Refer to the FES brochure for additional FES (wave) items, including carriers, tape, and hooks.



Forest Group is specialised in the development, production and supply of highly innovative curtain tracks and window coverings. We offer different curtain track solutions especially made for the hospitality industry. Whether you choose for our motorised curtain tracks or rods, blinds or manual curtain tracks your client will experience 'the Forest Factor'. Which stands for a unique combination of smooth hanging curtains, comfortable luxury and optimal ease of use.

THE WORLD BEHIND YOUR CURTAINS

More than thirty years ago it started with a flexible aluminium system, better known as Forest KS® system. The range was expanded at a rapid pace, always focusing on functionality and quality. The technologies conquered the world. Hotels all over the world are satisfied users of Forest systems and even iconic hotels like the Palazzo, the Venezian, both in Las Vegas and the mega hotels in Dubai were equipped with kilometers of tracks from Forest Group.

Forest Group supplies its products in more than 100 countries worldwide and has sales offices in The Netherlands, United States, China, United Arab Emirates, United Kingdom and Poland, ensuring a global availability of our products.

Some well-known and recognised features of the Forest Group curtain track systems are:

- **High-quality standards:** We guarantee a long lifespan.
- **Comfort and silence:** Curtains open and close silently, creating a serene and comfortable environment.
- **Adds style to windows:** Always perfectly hanging curtains thanks to our systems, including motorised solutions.
- **Smart integration:** Controllable via app, voice, and home automation systems for ultimate convenience.
- **Sustainability:** We use a minimum of 75% recycled aluminium.
- **Unique warranty:** 10-year warranty.



Curtain engineering by Forest