



MANUAL
OPERATION



HOTEL
TRACK

FOREST CS[®] Contract System

Heavy duty hand drawn curtain track system for medium and heavy draperies.

THE WORLD
BEHIND
YOUR
CURTAINS



FOREST CS®



PRODUCT INFORMATION

- Heavy duty hand drawn system for medium and heavy draperies.
- Bendable; it can be bent and reverse bent using a 20 cm (8") radius or continuous curve.
- Heavy duty clickable carriers - 10 carriers on a breakaway strip - UV protected. Can also be used with ball bearing carriers.
- Ideal for use with overlap masters and batons which can be mounted behind or in front of draperies.
- Can also be used for the Forest Wave System (FES) and accordiafold drapery systems.
- Maximum fabric weight: 15 kg per mtr (11,25 LBS per ft).
- Colours available: white, black and grey.
- Track finish: High quality aluminium, powder coated with a factory applied patented dry lubricant.
- Available lengths: 3.66 m (12'), 4.27 m (14'), 4.88 m (16'), 6.10 m (20')
- Warranty: 10 years

- 1 CS Track
- 2 Carrier
- 3 Master Carrier R/L Overlap
- 4 Master Carrier R/L Underlap
- 5 Ball bearing carrier
- 6 Endcap with screw

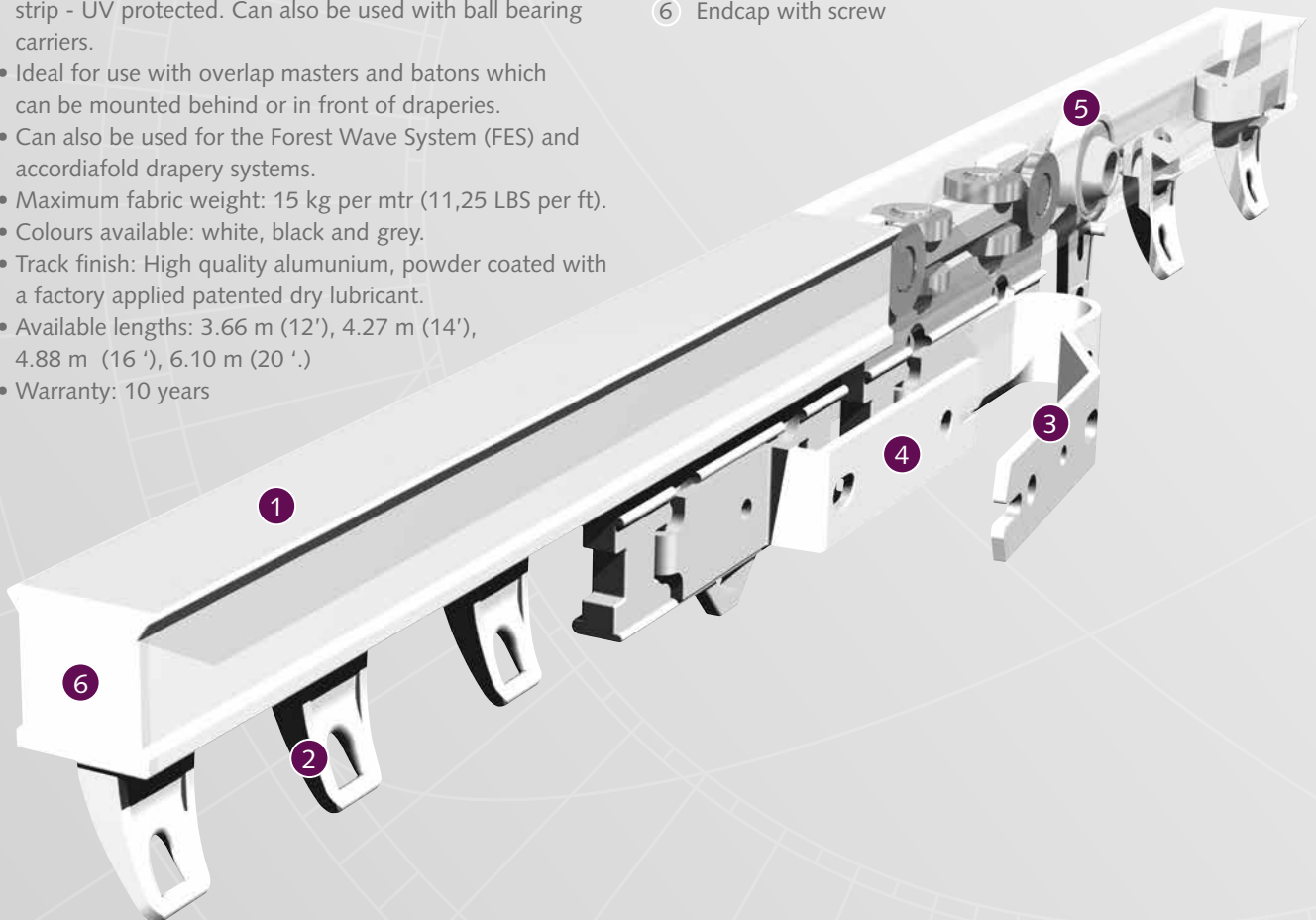



BENDING / CURVING

The track can be bent and reverse bent using a 20 cm (8") radius. Continuous curving is also possible with the electrical bending tool.

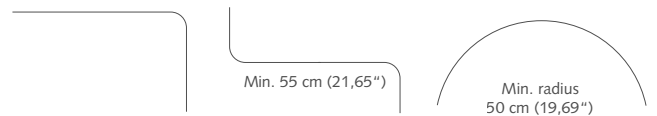

PROFILE

- Weight: 235 gram p. mtr (2.53 ounce - ft).
- Aluminium Extrusion
- Dimensions: 20 mm x 20 mm (0,8" x 0,8")

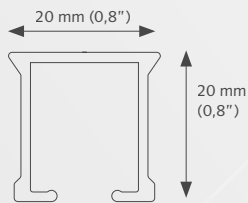

FOR USE IN

Hotels - Motels - offices - schools - healthcare residential or at any location where a heavy duty hand drawn system is required.

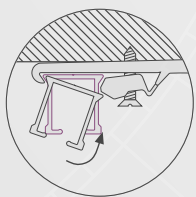

Easy installation
click - position - tighten

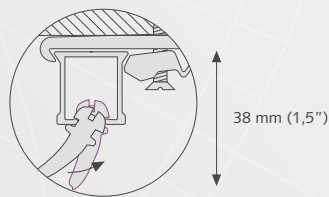

clickable carrier

APPLICATIONS

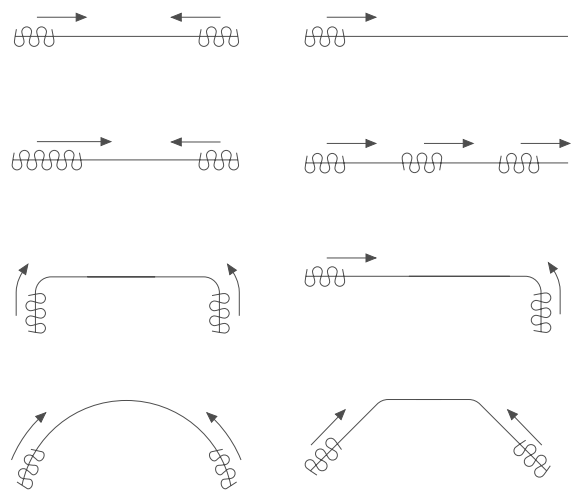

CLICK-ON STIFFENER

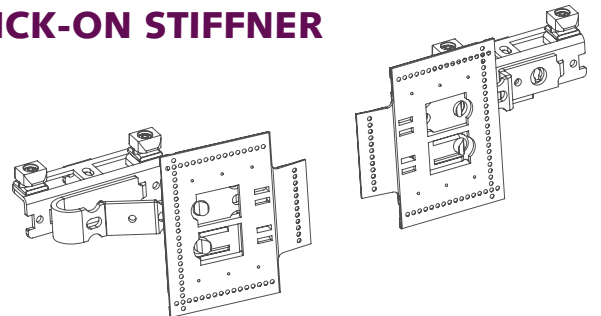

For applications where the curtains are treated very roughly, the stiffener is a sustainable solution. The stiffener makes curtains more robust and ensures that curtains last longer. Especially useful for hotels.

MOUNTING BRACKETS

Smart Klick Ceiling bracket

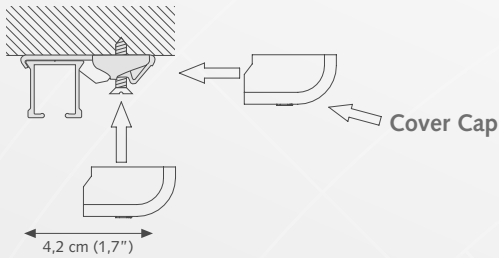

A) Min. 7,5 cm (2,9")



A) Min. 15 cm (5,9")

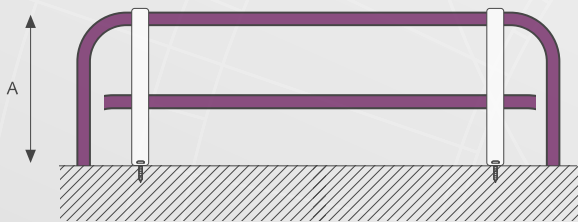

Other brackets are available. Brackets need to be placed every 60 cm (24").

SK Aluminium Wall bracket single

- A) 7,5 cm (3") B) 6,3 cm (2,5")
A) 10 cm (4") B) 8,8 cm (3,5")

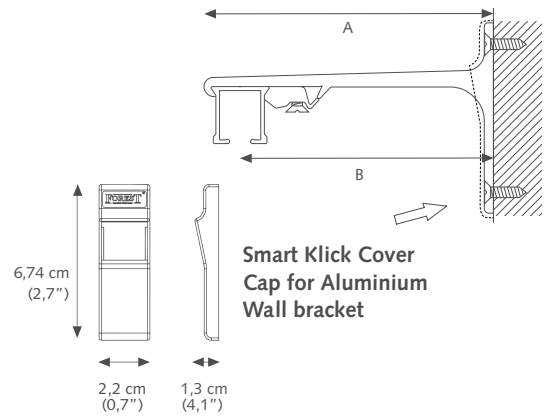

SK Aluminium Wall bracket double

- A) 15 cm (6") B) 9,2 cm (3,6") C) 4,5 cm (1,8")
A) 20 cm (8") B) 9,2 cm (3,6") C) 9,5 cm (3,7")

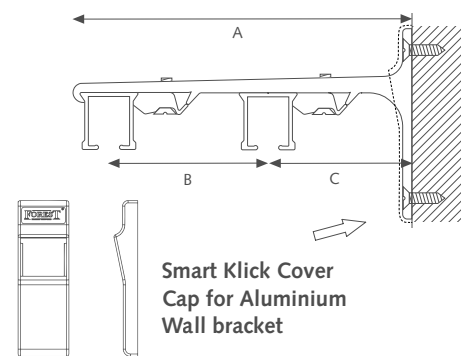





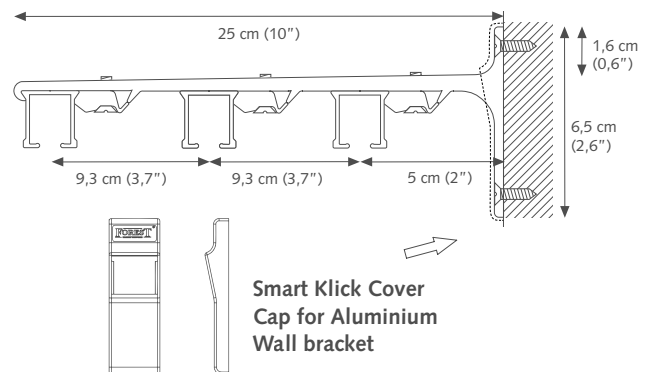

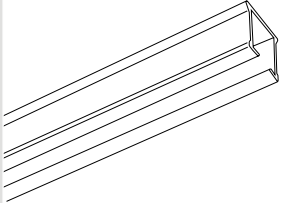
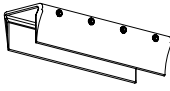
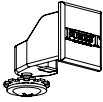
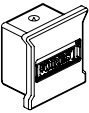
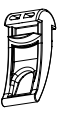

SK Aluminium Wall bracket triple

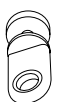

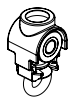
- A) 25 cm (10")

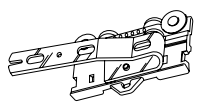

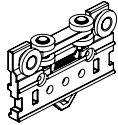
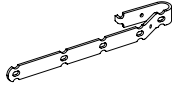
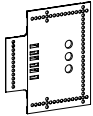
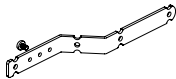
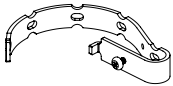

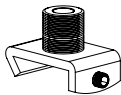
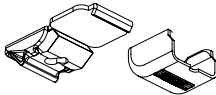
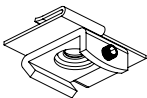
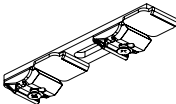
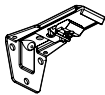
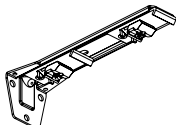
Brackets need to be placed every 50 - 60 cm (20" - 24"), depending on fabric weight.

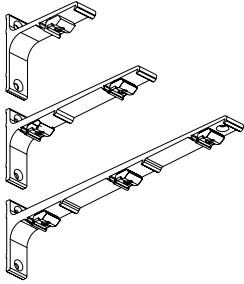
| CS | ARTICLE | PACKING UNIT | | ART.NR |
|----|---|--------------------|--|--|
| ● |  <p>CS TRACK WHITE Extruded aluminium chromated, powder coating, factory lubricated.</p> <p>CS TRACK GREY Extruded aluminium chromated, powder coating, factory lubricated</p> <p>CS TRACK BLACK Extruded aluminium chromated, powder coating, factory lubricated.</p> | 10/bundle | 3,66 meter (12') 4,27 meter (14') 4,88 meter (16') 6,10 meter (20') | 2501001366 2501001427 2501001488 2501001610 |
| ● |  <p>CS/CCS/FMS TRACK CONNECTOR Used to make a solid connection between two pieces of track.</p> | 10/box | white matt white grey black matt black | 2518401000-A 2518401000-A-M 2518403000-A 2518406000-A 2518406000-A-M |
| ● |  <p>CS ENDCAP UNIVERSAL LONG WITH SCREW</p> | 100/box | white silver black | 2516400000 2516403000 2516406000 |
| ● |  <p>CS ENDCAP UNIVERSAL SHORT WITH SCREW</p> | 100/box | white grey black | 2516401001 2516403001 2516406001 |
| ● |  <p>CS / CCS AS CARRIER "Clickable", offset, constructed of UV-resistant plastic. 10 Carriers on a break-away strip. Can be clicked in after</p> | 250/box | white silver black | 2510101000 2510103000 2510106000 |
| ● |  <p>CS STOPCARRIER Clickable.</p> | 100/box | white grey | 2510201000 2510203000 |
| ● |  <p>CS / CCS CARRIER AS WITH HOOK Clickable.</p> | 100/box | white grey | 2510501000 2510503000 |
| ● |  <p>CS ECONOMY SLIDE Can turn in the track.</p> | 500/box 500/box | white black | 2510601000 2510606000 |
| ● |  <p>CS BALL BEARING CARRIER 16MM SMALL</p> | 100/box | white black | 2512000016 2512006016 |
| ● |  <p>CONTRACT ROLLER CARRIER For a silent and smoothly operation with heavier curtains. Designed for use with butterfly pleats.</p> | 100/box | white black | 4831001000 4831006000 |
| ● |  <p>CS UNDERLAP CARRIER R/L</p> | 25/box | white | 2514600000 |
| ● |  <p>CS OVERLAP CARRIER R/L</p> | 25/box | white | 2514700000 |

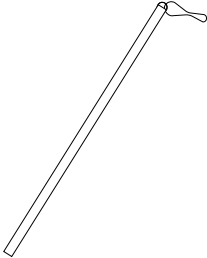
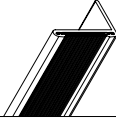
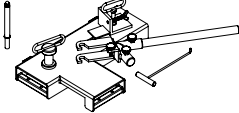
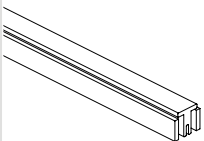
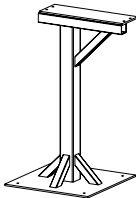
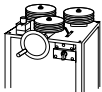
| CS | ARTICLE | PACKING UNIT | ART.NR |
|----|---|--------------|--|
| |  <p>CS MASTER CARRIER BASE R/L WHITE</p> | 25/box | white 481450000 |
| |  <p>PROLONGED OVERLAP ARM 150MM R/L FOR CLICK-ON STIFFNER</p> | 15/box | 9500001010 |
| |  <p>STIFFNER "CLICK-ON"</p> | 15/box | 5116001001 |
| |  <p>Z-ARM UNIVERSAL 175MM R/L</p> | 15/box | white 9500001030 |
| |  <p>FMS EASYFLEX CURVED ARM R/L WHITE</p> | 15/box | Pc. 5135901020 |
| |  <p>MTS SUSPENSION CEILING BRACKET Length: 10 cm (4") - 100 cm (40") Complete with MTS Insert Screw and MTS Top Piece</p> | 1/each | white 4518201000 |
| | <p>MTS SUSPENSION CEILING BRACKET 1,50 MTR WHITE Length: 100 cm (40") - 150 cm (59") Complete with MTS insert screw and MTS Top Piece</p> | 1/each | white black 4518201500 4518206150 |
| | <p>MTS SUSPENSION CEILING BRACKET 2,00 MTR WHITE Length: 200 cm (78") Complete with MTS insert screw and MTS Top Piece</p> | 1/each | white 4518202000 |
| |  <p>SUSPENSION BRACKET CLIP FOR KS For CS, to be used in combination with the MTS Suspension Ceiling Bracket.</p> | 50/box | white black 1016901000 1016906000 |
| |  <p>SMART KLICK CEILING BRACKET INCL COVER CAP "Klicks" onto track, powder coated.</p> | 100/box | white grey black 1018201001 1018203001 1018206001 |
| |  <p>FALSE CEILING BRACKET (METAL) For installation on to a suspended ceiling. The track can be fixed in any angle.</p> | 25/box | white 4519001000 |
| |  <p>SMART KLICK CEILING BRACKET DOUBLE LONG Distance between two tracks: 90 mm (3,5")</p> | 30/box | white 1018601000 |
| | <p>SMART KLICK CEILING BRACKET DOUBLE SHORT</p> | | 1018611000 |
| |  <p>KS ADJUSTABLE WALL BRACKET, SINGLE</p> | 100/box | white grey 1020801115 1020803115 |
| |  <p>KS ADJUSTABLE WALL BRACKET, DOUBLE</p> | 50/box | white grey 1020801195 1020803195 |

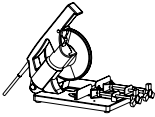
| CS | ARTICLE | PACKING UNIT | | ART.NR | |
|----|---|--|----------------|-------------------------------------|--|
| ● |  | ALUMINIUM WALL BRACKET 7.5 cm single (3') | 20/box | white grey black | 1020301075 1020303075 1020306075 |
| | | ALUMINIUM WALL BRACKET 10 cm single (4') | 20/box | white grey black | 1020301100 1020303100 1020306100 |
| | | ALUMINIUM WALL BRACKET 15 cm double (6') | 15/box | white grey black | 1020301150 1020303150 1020306150 |
| | | ALUMINIUM WALL BRACKET 20 cm double (8') | 15/box | white grey black | 1020301200 1020303200 1020306200 |
| | | ALUMINIUM WALL BRACKET 25 cm triple (10') | 15/box | white grey black | 1020301250 1020303250 1020306250 |
| ● |  | COVER CAP FOR SMART KLICK ALUMINIUM WALL BRACKET | 50/box | white grey black | 1021301000 1021303000 1021306000 |
| ● |  | FLICKSTICK FIBERGLASS | 50/box | 92 cm 122 cm 152 cm | 1065101092 1065101122 1065101152 |
| | | FLICKSTICK TRANSPARENT | 50/box | 92 cm 122 cm 152 cm | 1065102092 1065102122 1065102152 |
| | | FLICKSTICK WHITE ALUMINIUM | 50/box | 92 cm 122 cm 152 cm 202 cm | 1065111092 1065111122 1065111152 1065111202 |
| | | FLICKSTICK SILVER ALUMINIUM | 50/box | 92 cm 122 cm 152 cm | 1065113092 1065113122 1065113152 |
| | | FLICKSTICK BLACK ALUMINIUM | 50/box | 92 cm 122 cm 152 cm | 1065116092 1065116122 1065116152 |
| | | FLICKSTICK ANTIQUE ALUMINIUM | 50/box | 92 cm 122 cm 152 cm | 1065119092 1065119122 1065119152 |
| ● |  | VELCRO HOTEL PROFILE Inside frame fix, to reduce light leakage in combination with Looptape | 120 mtr/bundle | | 3581601600 |
| | | LOOPTAPE | 25 mtr/roll | | 3816202020 |
| ● |  | CONTRACT BENDING TOOL BASIC (without bending wheel) | 1/each | | 2560000000 |
| | | CS/CCS/FMS BENDING WHEEL | 1/each | | 2561000000 |
| ● |  | CS/FMS BENDING STRIPS For CS track, length: 90 cm (35,4") | 1/set | | 8500000001 |
| | | CS/FMS BENDING STRIP FOR ELECTRIC POWERED BENDER Length 7 meter (23') | 1/piece | | 5160100010 |
| ● |  | BENDING STAND Stand for contract bending tool | 1/each | | 2560800000 |
| ● |  | ELECTRIC POWERED BENDER Available in 230V or 115V To create continuous curves and arches minimum radius 50 cm (20") | 1/each | | 1060500000 |

| CS | | ARTICLE | PACKING UNIT | ART.NR |
|----|---|---|--------------|------------|
| ● |  | CS/CCS BENDING WHEELS For Electric Powered Bender. Complete set of 3 wheels. | 1/set | 2560700000 |
| ● | sample image  | ELECTRIC POWERED RAILCUTTER 230 Volt EU | 1/each | 1061100000 |
| | | BLADE FOREST CUTTER NEW MODEL | 1/each | 1061200001 |
| ● |  | FOREST LUBRICANT To lubricate components during assembly. | 1/each | 5109010000 |

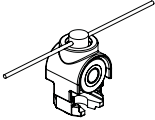
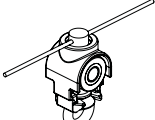
| EASYWAVE | EASYFLEX | GENERAL WAVE COMPONENTS | ARTICLE | PACKING UNIT | ART.NR | |
|----------|----------|---|--|--------------|----------------|--------------------------|
| | ● |  | CONTRACT EASYFOLD BASE ROLLER 60% 80MM For a silent and smoothly operation on CS, FMS Dual and CRS 28mm | 500/roll | white black | 4833001060 4833006060 |
| | | | CONTRACT EASYFOLD BASE ROLLER 80% 60MM For a silent and smoothly operation on CS, FMS Dual and CRS 28mm | | white black | 4833001080 4833006080 |
| ● | |  | CONTRACT EASYWAVE ROLLER 60% 80MM For a silent and smoothly operation on CS, FMS Dual and CRS 28mm | 500/roll | white black | 4832001060 4832006060 |
| | | | CONTRACT EASYWAVE ROLLER 80% 60MM For a silent and smoothly operation on CS, FMS Dual and CRS 28mm | | white black | 4832001080 4832006080 |