



MANUAL
OPERATION



HOTEL
TRACK

FOREST CS[®] *Contract System*

Heavy duty hand drawn curtain track system for medium and heavy draperies.

THE WORLD
BEHIND
YOUR
CURTAINS



FOREST CS®



PRODUCT INFORMATION

- Heavy duty hand drawn system for medium and heavy draperies.
- Bendable; it can be bent and reverse bent using a 20 cm (8") radius or continuous curve.
- Heavy duty clickable carriers - 10 carriers on a breakaway strip - UV protected. Can also be used with ball bearing carriers.
- Ideal for use with overlap masters and batons which can be mounted behind or in front of draperies.
- Can also be used for the Forest Wave System (FES) and accordiafold drapery systems.
- Maximum fabric weight: 15 kg per mtr (11,25 LBS per ft).
- Colours available: white, black and grey.
- Track finish: High quality aluminium, powder coated with a factory applied patented dry lubricant.
- Available lengths: 3.66 m (12'), 4.27 m (14'), 4.88 m (16'), 6.10 m (20')
- Warranty: 10 years

- 1 CS Track
- 2 Carrier
- 3 Master Carrier R/L Overlap
- 4 Master Carrier R/L Underlap
- 5 Ball bearing carrier
- 6 Endcap with screw

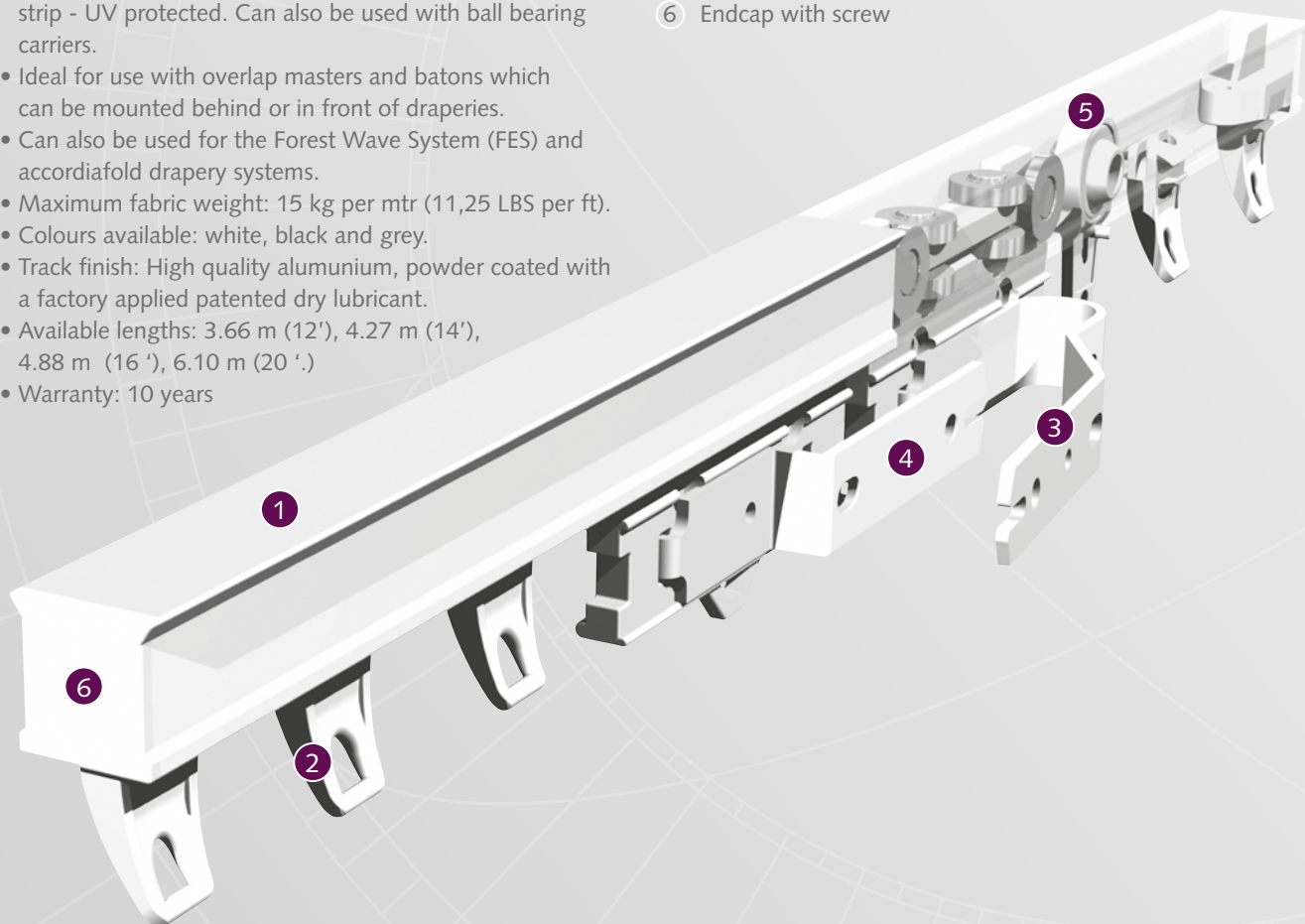



PROFILE

- Weight: 235 gram p. mtr (2.53 ounce - ft).
- Aluminium Extrusion
- Dimensions: 20 mm x 20 mm (0,8" x 0,8")

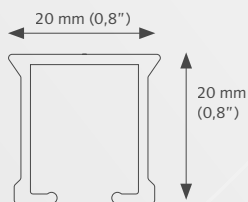

FOR USE IN

Hotels - Motels - offices - schools - healthcare residential or at any location where a heavy duty hand drawn system is required.

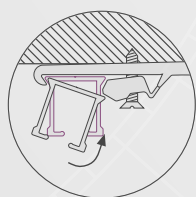

Easy installation
click - position - tighten

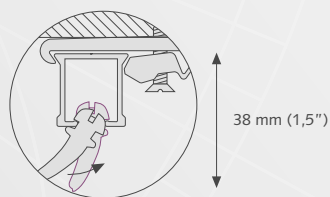

clickable carrier

BENDING / CURVING

The track can be bent and reverse bent using a 20 cm (8") radius. Continuous curving is also possible with the electrical bending tool.

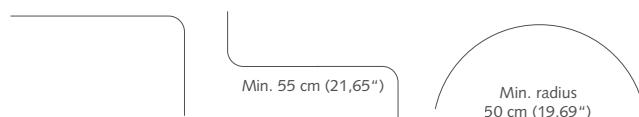

APPLICATIONS

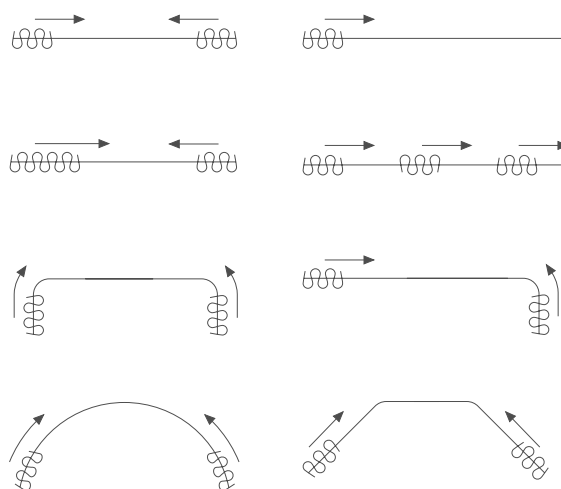

CLICK-ON STIFFENER

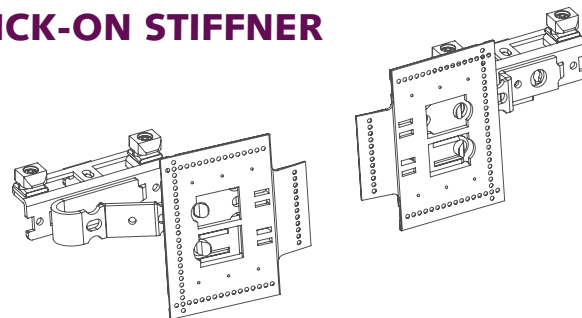

For applications where the curtains are treated very roughly, the stiffener is a sustainable solution. The stiffener makes curtains more robust and ensures that curtains last longer. Especially useful for hotels.

MOUNTING BRACKETS

Smart Klick Ceiling bracket

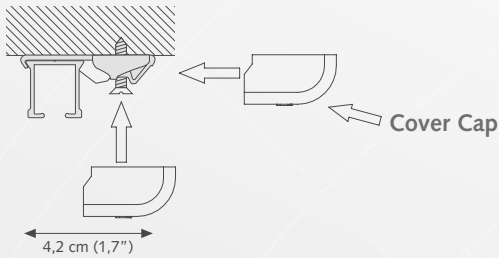

A) Min. 7,5 cm (2,9")



A) Min. 15 cm (5,9")

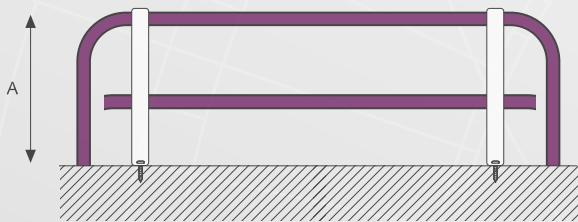

Other brackets are available. Brackets need to be placed every 60 cm (24").

SK Aluminium Wall bracket single

- A) 7,5 cm (3") B) 6,3 cm (2,5")
 A) 10 cm (4") B) 8,8 cm (3,5")

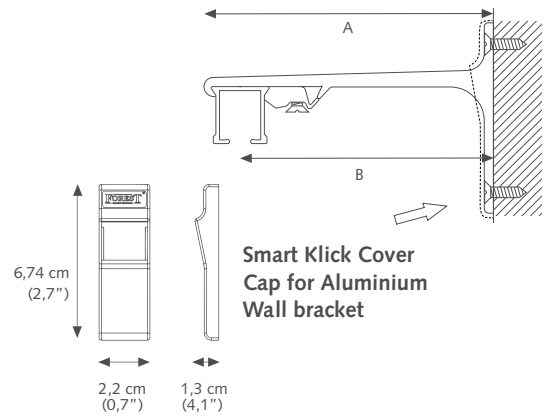

SK Aluminium Wall bracket double

- A) 15 cm (6") B) 9,2 cm (3,6") C) 4,5 cm (1,8")
 A) 20 cm (8") B) 9,2 cm (3,6") C) 9,5 cm (3,7")

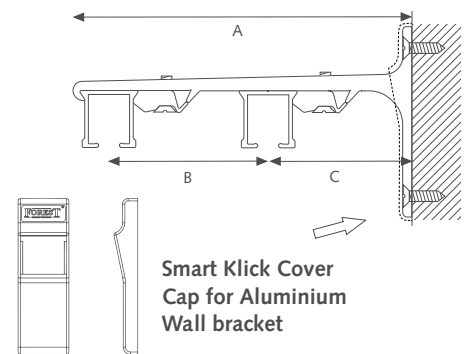





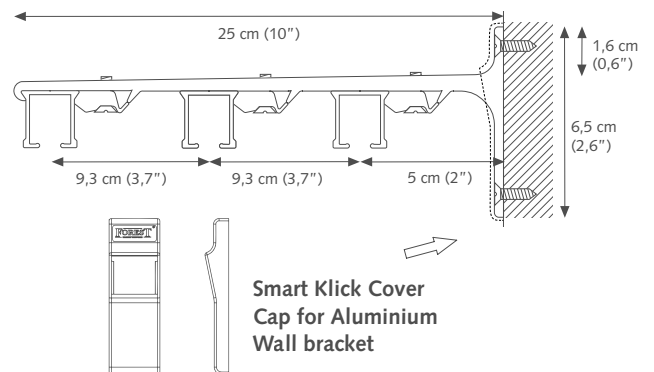



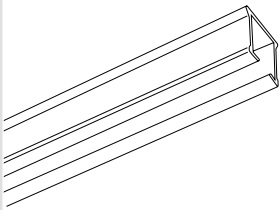
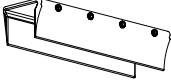
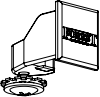
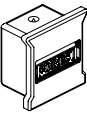

SK Aluminium Wall bracket triple



- A) 25 cm (10")

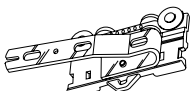

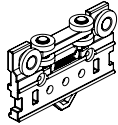
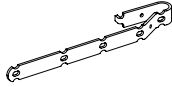
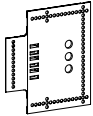
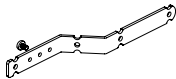
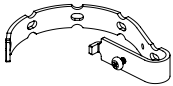

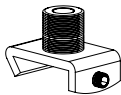
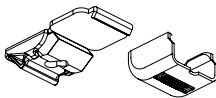
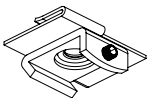
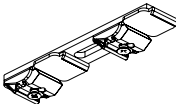
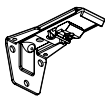
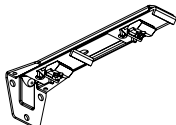
Brackets need to be placed every 50 - 60 cm (20"-24"), depending on fabric weight.

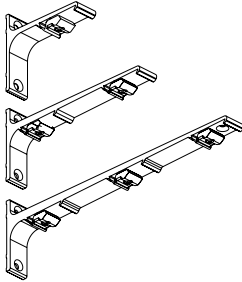
CS	ARTICLE	PACKING UNIT	ART.NR
●	 <p>CS TRACK WHITE Extruded aluminium, powder coating, factory lubricated.</p>	10/bundle	3,66 meter (12') 2501001366 4,27 meter (14') 2501001427 4,88 meter (16') 2501001488 6,10 meter (20') 2501001610
	<p>CS TRACK GREY Extruded aluminium, powder coating, factory lubricated</p>	10/bundle	6,10 meter (20') 2501003610
	<p>CS TRACK BLACK Extruded aluminium, powder coating, factory lubricated.</p>	10/bundle	6,10 meter (20') 2501006610
●	 <p>CS/CCS/FMS TRACK CONNECTOR Used to make a solid connection between two pieces of track.</p>	10/box	white 2518401000-A matt white 2518401000-A-M grey 2518403000-A black 2518406000-A matt black 2518406000-A-M
●	 <p>CS ENDCAP UNIVERSAL LONG WITH SCREW</p>	100/box	white 2516400000 silver 2516403000 black 2516406000
●	 <p>CS ENDCAP UNIVERSAL SHORT WITH SCREW</p>	100/box	white 2516401001 grey 2516403001 black 2516406001
●	 <p>CS / CCS AS CARRIER Clickable, offset, constructed of UV-resistant plastic. 10 Carriers on a break-away strip. Can be clicked in after.</p>	250/box	white 2510101000 grey 2510103000 black 2510106000
●	 <p>CS STOPCARRIER Clickable</p>	100/box	white 2510201000
●	 <p>CS / CCS CARRIER AS WITH HOOK Clickable</p>	100/box	white 2510501000
●	 <p>CS ECONOMY SLIDE Can turn in the track.</p>	500/box 500/box	white 2510601000 black 2510606000
●	 <p>CS BALL BEARING CARRIER 16MM SMALL</p>	100/box	white 2512000016 black 2512006016
●	 <p>CONTRACT ROLLER CARRIER For a silent and smoothly operation with heavier curtains. Designed for use with butterfly pleats.</p>	100/box	white 4831001000 black 4831006000
●	 <p>CS UNDERLAP CARRIER R/L</p>	25/box	white 2514600000
●	 <p>CS OVERLAP CARRIER R/L</p>	25/box	white 2514700000

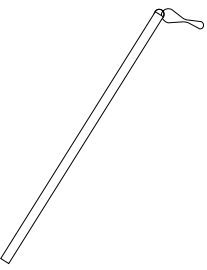
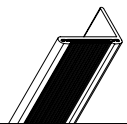
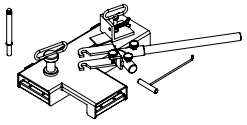
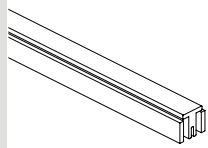
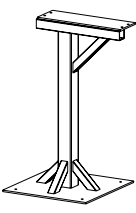
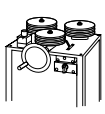
CS	ARTICLE	PACKING UNIT	ART.NR
	 <p>CS MASTER CARRIER BASE R/L WHITE</p>	25/box	white 481450000
	 <p>PROLONGED OVERLAP ARM 150MM R/L for click-on stiffner</p>	15/box	white 9500001010
	 <p>STIFFNER "CLICK-ON"</p>	15/box	5116001001
	 <p>Z-ARM UNIVERSAL 175MM R/L Ideal for blackout</p>	15/box	white black 9500001030 9500006030
	 <p>FMS EASYFLEX CURVED ARM R/L WHITE</p>	15/box	white black 5135901020 5135906020
	 <p>MTS SUSPENSION CEILING BRACKET Length: 10 cm (4") - 100 cm (40") Complete with MTS Insert Screw and MTS Top Piece</p>	1/each	white 4518201000
	<p>MTS SUSPENSION CEILING BRACKET 1,50 MTR WHITE Length: 100 cm (40") - 150 cm (59") Complete with MTS insert screw and MTS Top Piece</p>	1/each	white black 4518201500 4518206150
	<p>MTS SUSPENSION CEILING BRACKET 2,00 MTR WHITE Length: 200 cm (78") Complete with MTS insert screw and MTS Top Piece</p>	1/each	white 4518202000
	 <p>SUSPENSION BRACKET CLIP FOR KS For CS, to be used in combination with the MTS Suspension Ceiling Bracket.</p>	50/box	white black 1016901000 1016906000
	 <p>SMART KLICK CEILING BRACKET INCL COVER CAP "Klicks" onto track, powder coated.</p>	100/box	white grey black 1018201001 1018203001 1018206001
	 <p>FALSE CEILING BRACKET (METAL) For installation on to a suspended ceiling. The track can be fixed in any angle.</p>	25/box	white black 4519001000 4519006000
	 <p>SMART KLICK CEILING BRACKET DOUBLE LONG Distance between two tracks: 90 mm (3,5")</p>	30/box	white black 1018601000 1018606000
	<p>SMART KLICK CEILING BRACKET DOUBLE SHORT</p>		1018611000
	 <p>KS ADJUSTABLE WALL BRACKET, SINGLE 7,5 - 11,5 cm</p>	100/box	white grey 1020801115 1020803115
	 <p>KS ADJUSTABLE WALL BRACKET, DOUBLE 6,5 - 19,5 cm</p>	50/box	white 1020801195

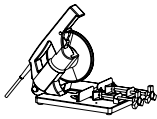
CS	ARTICLE	PACKING UNIT	ART.NR	
●		ALUMINIUM WALL BRACKET 7.5 cm single (3')	20/box white grey black	1020301075 1020303075 1020306075
		ALUMINIUM WALL BRACKET 10 cm single (4')	20/box white grey black	1020301100 1020303100 1020306100
		ALUMINIUM WALL BRACKET 15 cm double (6')	15/box white grey black	1020301150 1020303150 1020306150
		ALUMINIUM WALL BRACKET 20 cm double (8')	15/box white grey black	1020301200 1020303200 1020306200
		ALUMINIUM WALL BRACKET 25 cm triple (10')	15/box white grey black	1020301250 1020303250 1020306250
●		COVER CAP FOR SMART KLICK ALUMINIUM WALL BRACKET	50/box white grey black	1021301000 1021303000 1021306000
●		FLICKSTICK FIBERGLASS	50/box 92 cm 122 cm 152 cm	1065101092 1065101122 1065101152
		FLICKSTICK TRANSPARENT	50/box 92 cm 122 cm 152 cm	1065102092 1065102122 1065102152
		FLICKSTICK WHITE ALUMINIUM	50/box 92 cm 122 cm 152 cm 202 cm	1065111092 1065111122 1065111152 1065111202
		FLICKSTICK SILVER ALUMINIUM	50/box 92 cm 122 cm 152 cm	1065113092 1065113122 1065113152
		FLICKSTICK BLACK ALUMINIUM	50/box 92 cm 122 cm 152 cm	1065116092 1065116122 1065116152
		FLICKSTICK ANTIQUE ALUMINIUM	50/box 92 cm 122 cm 152 cm	1065119092 1065119122 1065119152
●		VELCRO HOTEL PROFILE Inside frame fix, to reduce light leakage in combination with Looptape	120 mtr/bundle	3581601600
		LOOPTAPE	25 mtr/roll	3816202020
●		CONTRACT BENDING TOOL BASIC (without bending wheel)	1/each	2560000000
		CS/CCS/FMS BENDING WHEEL	1/each	2561000000
●		CS/FMS BENDING STRIPS For CS track, length: 90 cm (35,4")	1/set	8500000001
		CS/FMS BENDING STRIP FOR ELECTRIC POWERED BENDER Length 7 meter (23')	1/piece	5160100010
●		BENDING STAND Stand for contract bending tool	1/each	2560800000
●		ELECTRIC POWERED BENDER Available in 230V or 115V To create continuous curves and arches minimum radius 50 cm (20")	1/each	1060500000

CS		ARTICLE	PACKING UNIT	ART.NR
●		CS/CCS BENDING WHEELS For Electric Powered Bender. Complete set of 3 wheels.	1/set	2560700000
●	sample image 	ELECTRIC POWERED RAILCUTTER 230 Volt EU	1/each	1061100000
		BLADE FOREST CUTTER NEW MODEL	1/each	1061200001
●		FOREST LUBRICANT To lubricate components during assembly.	1/each	5109010000

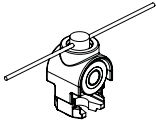
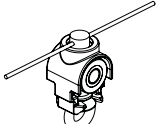
EASYWAVE	EASYFLEX	GENERAL WAVE COMPONENTS	ARTICLE	PACKING UNIT	ART.NR
	●		CONTRACT EASYFOLD BASE ROLLER 60% 80MM For a silent and smoothly operation on CS, FMS Dual and CRS 28mm	500/roll white black	4833001060 4833006060
			CONTRACT EASYFOLD BASE ROLLER 80% 60MM For a silent and smoothly operation on CS, FMS Dual and CRS 28mm	white black	4833001080 4833006080
●			CONTRACT EASYWAVE ROLLER 60% 80MM For a silent and smoothly operation on CS, FMS Dual and CRS 28mm	500/roll white black	4832001060 4832006060
			CONTRACT EASYWAVE ROLLER 80% 60MM For a silent and smoothly operation on CS, FMS Dual and CRS 28mm	white black	4832001080 4832006080