



DOMOTICA **APP** **DRAADLOZE** **KOORD**
READY **BEDIENING** **BEDIENING** **BEDIENING**

FOREST ATLANTIS[®] Series

Ontdek onze rolgordijssystemen en stoffen.
Verkrijgbaar als ketting-, slinger- of gemotoriseerd systeem.

FOREST ATLANTIS[®]
FOREST ATLANTIS[®] Slim Line



THE WORLD
BEHIND
YOUR
CURTAINS

FOREST ATLANTIS®

PRODUCT INFORMATIE

- Buis beschikbaar in 50 mm en 60 mm.
- Kettingbediend en gemotoriseerd systeem.
- Kettingbediening 1:2.
- Eenvoudige montage met verstelbare steunen.
- Forest buismotoren en bedieningen zijn toepasbaar.
- Maximaal totaal gewicht is 26 kg bij een 13Nm Forest buismotor.
- Forest buismotor is ultra stil: < 44 dB(A).
- Forest buismotor verkrijgbaar in: 3Nm, 6Nm en 13Nm.
- Bediening via app (via Wireless Connector icm slimme stekker) of domotica is mogelijk.
- Forest buismotor ook beschikbaar met ingebouwde ontvanger en elektronische afstelling eindposities.
- Koppeling van meerdere rolgordijnen op 1 buismotor is mogelijk.
- Elegante afdekkap en zijgeleiding zijn optioneel.
- Drie montagemogelijkheden: nis, plafond, wand
- 50 mm geschikt voor breedtes tot 250 cm.
- 60 mm geschikt voor breedtes tot 300 cm.
- 60 mm geschikt voor breedtes tot 400 cm.
- 50 mm geschikt voor hoogte stof (0,3 mm) tot 550 cm.
- 60 mm geschikt voor hoogte stof (0,3 mm) tot 400 cm.

TE GEBRUIKEN IN

Hotels - kantoren - woningen - boten of overal waar een rolgordijnsysteem voor zwaar gebruik nodig is voor maximale verduistering of decoratief gebruik.

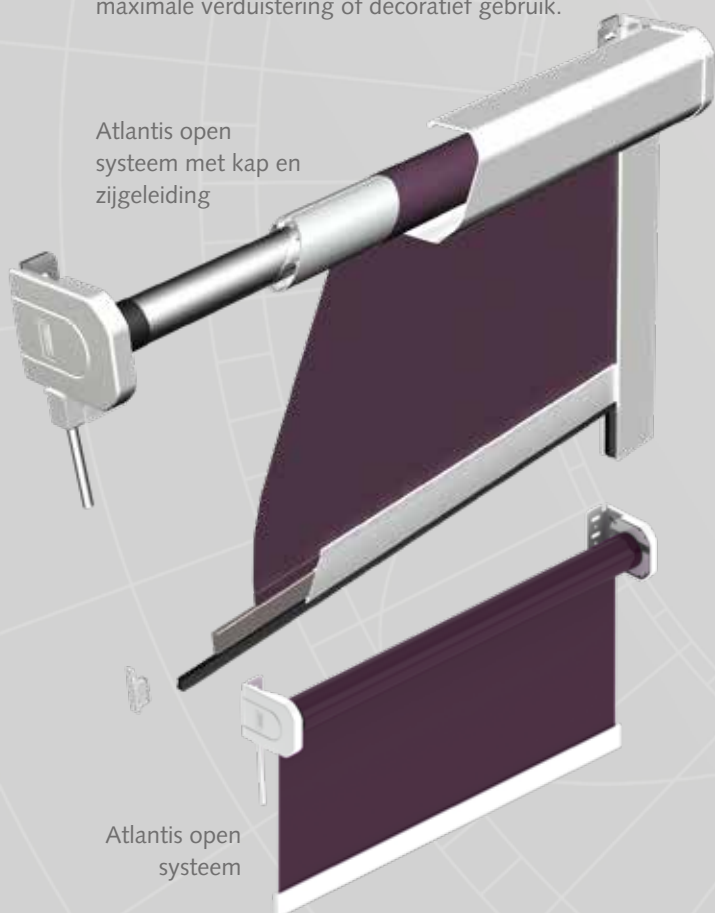

PROFIEL

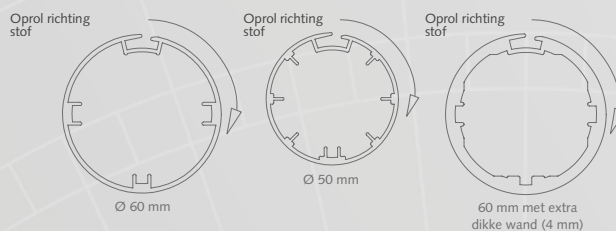

- Afmeting: Ø 50 mm en 60 mm
- Gewicht: 850 gram/meter en 1.200 gram/meter
- Aluminium extrusie

SPECIFICATIES

Type	Sterkte	Snelheid	Gewichtsbelasting	Geluidsniveau	Bedieningsmogelijkheden
6/28/S	6 Nm	28 rpm	13 kg	< 44 dB(A)	Schakelaar / Domotica
6/20/SQ	6 Nm	20 rpm	13 kg	< 40 dB(A)	Schakelaar / Domotica
13/14/S	13 Nm	14 rpm	26 kg	< 44 dB(A)	Schakelaar / Domotica
6/28/E	6 Nm	28 rpm	13 kg	< 44 dB(A)	Forest Multi Interne Ontvanger
6/20/EQ	6 Nm	20 rpm	13 kg	< 40 dB(A)	Forest Multi Interne Ontvanger
13/14/E	13 Nm	14 rpm	26 kg	< 44 dB(A)	Forest Multi Interne Ontvanger



FOREST ATLANTIS® Slim Line

PRODUCT INFORMATIE

- Buis verkrijgbaar in 40 mm.
- Ketting- of slingerbediend en gemotoriseerd systeem.
- Eenvoudige installatie met universele verstelbare steunen.
- Forest buismotoren en bedieningen kunnen worden gebruikt.
- Maximaal totaalgewicht 3,5 kg.
- Stil bewegend gemotoriseerd rolgordijnsysteem.
Geluidsniveau < 44 dB(A).
- Geschikt voor domotica.
- Buismotor ook verkrijgbaar met interne multi-ontvanger en elektronische eindbegrenzing.
- Koppeling van meerdere rolgordijnen op 1 buismotor is mogelijk.
- Afdekcassette en zijgeleiders beschikbaar.
- Batterij-buismotor ook verkrijgbaar.
- Drie montagemogelijkheden: nis, plafond, wand.
- Breedte tot 250 cm.
- Hoogte stoffen (0,3 mm) tot 390 cm.
- Kettingbediening opties: 1:2 / 1:1
- Slingerbediening: 1-2,5.

TE GEBRUIKEN IN

Hotels - kantoren - woningen - boten of overal waar een middelzwaar rolgordijnsysteem nodig is voor maximale verduistering of decoratief gebruik.

PROFIEL

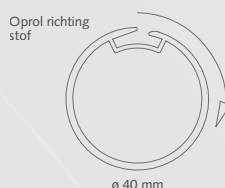

- Afmeting: Ø 40 mm
- Gewicht: 556 grams/meter en 685 grams/meter
- Aluminium extrusie

SPECIFICATIES

Type	Snelheid	Gewichts- belasting	Geluidsniveau	Bedienings mogelijkheden
12/28/S	28rpm	3,5 kg	< 44 dB(A)	Schakelaar / Domotica
RF230/32/E	32rpm	3,5 kg	< 44 dB(A)	Forest Multi Interne Ontvanger

Atlantis Slim Line
gesloten systeem



Atlantis Slim Line
open systeem

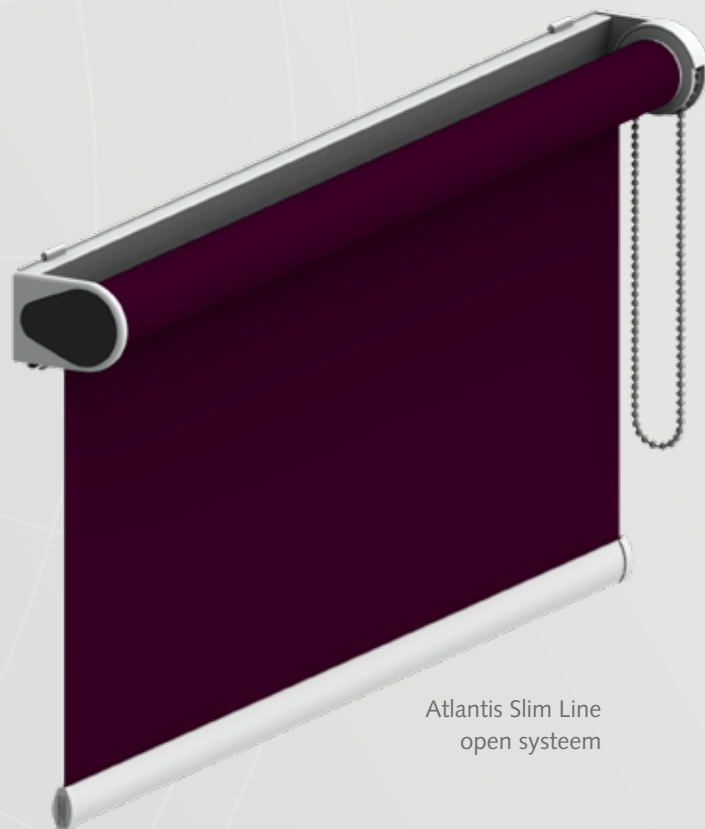

ATLANTIS® STOFFEN COLLECTIE

Voor onze Atlantis & Atlantis Slim Line rolgordijnsysteem bieden we een ruime keuze aan stoffen voor de projectmarkt. Deze collectie van unieke stoffen levert de prestaties en duurzaamheid waar de projectmarkt om vraagt en biedt passende oplossingen voor elk interieur. Naast de variaties aan stoffen bieden we ook een goed doordacht kleurenpalet. De collectie is een selectie van acht verschillende stoffen. Naast lichtdoorlatende en verduisterende stoffen bieden we ook special varianten aan zoals Eco Blackout, Medi blackout en Acoustic dimout stoffen. Uiteraard zijn alle variaties brandwerend.

De stoffen zijn verkrijgbaar in de maten 240, 305 en 310 cm. Daarmee is het ook ideaal voor grote ramen.

STOFFENWAAIER MET OVERZICHT

De stoffen kunnen uiteraard niet zonder een fraaie presentatie. Daarom hebben we een stofferwaaier in handzaam formaat samengesteld die u ondersteunt in het verkoopproces. De waaier is een handzame stalengids voor kennis over de nieuwe materialen, zoals de samenstelling, eigenschappen en kwaliteiten. Per stof hebben we een infobladd toegevoegd met info van alle materialen, vjzels, vezels en weefsels. In totaal bestaat de waaier uit 49 verschillende stoffen.



FOREST SHADE 3%

Forest Shade 3% is een pvc-vrij materiaal met een openheidsfactor van 3%. De rechthoekige structuur van het materiaal verhindert inkijk en garandeert zo privacy. Omgekeerd blijft naar buiten kijken gewoon mogelijk, en dat zonder hinderlijke schittering.

KLEUROPTIES

0125011305

Snow



0125014305

Dusty Fawn



0125013305

Grey Haze



0125015305

Charcoal



0125012305

Ivory



0125016305

Rich Black



FOREST FG SHADE 3% & 5%

Forest FG Shade is een glasvezel product met een pvc-coating en is leverbaar met een openheidsfactor van 3% en 5%, afhankelijk van specifieke eisen op het gebied van licht en temperatuur.

KLEUROPTIES

3%: 0125071310

5%: 0125081310

White



3%: 0125072310

5%: 0125082310

White Linen



3%: 0125073310

5%: 0125083310

White Pearl



3%: 0125074310

5%: 0125084310

Linen



3%: 0125075310

5%: 0125085310

Pearl



3%: 0125076310

5%: 0125086310

Black Grey

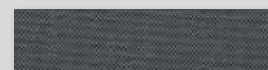

3%: 0125077310

5%: 0125087310

Black



FOREST BLACKOUT 0%

Ons blackout product bereikt een nieuw niveau van licht- en zonwering en staat voor een optimaal blackout effect. De kleur van deze blackout stof is aan beide zijden gelijk.

KLEUROPTIES

0125031305

Snow



0125034305

Dusty Fawn



0125033305

Grey Haze



0125035305

Charcoal



0125032305

Ivory



0125036305

Rich Black



FOREST ECO BLACKOUT 0%

We presenteren nu ook Forest ECO Blackout, een duurzaam materiaal dat ook zorgt voor een blackout effect. De stof bestaat voor tenminste 80% uit gerecycled polyester. Drie tot vier gerecyclede PET-flessen zijn goed voor één vierkante meter duurzaam materiaal. Recycling verlengt de levensduur van ruwe grondstoffen. Dat reduceert de behoefte aan die grondstoffen en vergroot duurzaamheid.

KLEUROPTIES

0125041310

Snow



0125042310

Cream



0125043310

Grey Haze



0125044310

Perfect Greige



0125046310

Midnight Black



FOREST SHADE ALU 3%

Forest Shade Alu heeft een extreem fijnmazige rechthoekige structuur die toch uitstekende transparantie biedt bij een lage openheidsfactor van 3%. Enerzijds zorgt het gebruik van aluminium voor goede bescherming tegen ongewenste schitteringen, anderzijds is Forest Shade Alu van buitenaf nauwelijks te zien door de fijne structuur van het materiaal.

KLEUROPTIES

0125021290

Snow



0125024290

Dusty Fawn



0125023290

Grey Haze



0125025290

Charcoal



0125022290

Ivory



0125026290

Rich Black



FOREST MEDI BLACKOUT 0%

Voor specifieke situaties biedt de collectie van Forest specifieke materialen. Onze kwalitatief hoogstaande medi-blackout is er voor omgevingen met verhoogde hygiëne, zoals ziekenhuizen of andere medische voorzieningen. Het maakt gebruik van de antibacteriële kwaliteiten van zilver.

KLEUROPTIES

0125051310

Pure White

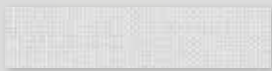

0125054310

Basalt

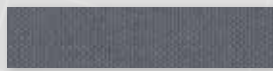

0125052310

Canvas

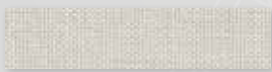

0125055310

Olive Grey



0125053310

Silver



0125056310

Charcoal



FOREST ACOUSTIC DIMOUT 1%

Forest Acoustic Dimout absorbeert geluid en is daarmee zeer geschikt voor gebruik in kantoren. Dit product heeft een openheidsfactor van 1%.

KLEUROPTIES

0125061240

Snow



0125064240

Dusty Fawn



0125063240

Grey Haze

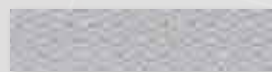

0125065240

Charcoal



0125062240

Ivory



0125066240

Rich Black



FOREST ATLANTIS® / ATLANTIS® Slim Line

FOREST ATLANTIS® WERKT O.A. MET



BUSCH-JAEGER



GIRA

Control4



* Werkt alleen met een actuator.

Forest® Atlantis Slim Line is compatibel met nog vele andere gebouwbeheer- en domotica systemen.

BEDIENINGSMOGELIJKHEDEN

Met het ruime aanbod aan beschikbare bedieningsmogelijkheden kiest u eenvoudig een passende oplossing die het beste bij u past: handbediend, via een afstandsbediening of sluit het Atlantis® gemotoriseerd systeem aan op uw domotica/gebouwautomatisering systeem.



AFSTANDSBEDIENING

We bieden twee soorten RF-afstandsbedieningen: de EasyTouch en de Diamond Sense.

- De EasyTouch bedient tot 6 systemen, waarbij ongebruikte kanalen gedeactiveerd kunnen worden.
- De Diamond Sense is een 15 of 2 kanaals afstandsbediening met LED display. De systemen kunnen handmatig of met de geïntegreerde timer worden bediend. Het LED-display licht automatisch op zodra je je hand erboven beweegt.

Bereik van beide afstandsbedieningen is tot wel 30 meter.



APP BEDIENING VIA FOREST WIFI-DONGLE

Met de Shuttle® Wi-Fi-dongle kunt u uw gemotoriseerde rolgordijnen met uw mobiele apparaat bedienen via de Forest Connect app of zelfs via spraakbediening via Google Home of Amazon Echo zonder dat u een extra hub of gateway nodig heeft.

APP BEDIENING VIA FOREST WIRELESS CONNECTOR

De Forest Wireless Connector biedt een eenvoudige oplossing om gemotoriseerde rolgordijnen van Forest 'slim' te maken. Samen met een slimme stekker kunt u moeiteloos uw rolgordijnen bedienen via een app. Met bediening via de App kunt u meerdere rolgordijnen tegelijk of los van elkaar bedienen, thuis of op afstand. Creëer uw eigen scènes zodat de gordijnen op ieder gewenst moment doen wat u wilt. Als u de Forest Connect App wilt gebruiken, kunt u kiezen voor de slimme stekker van Forest. Als u echter uw gordijnen wilt bedienen met behulp van Apple HomeKit, Amazon Alexa of Google Assistant, heeft u een compatibele slimme stekker van derden nodig die werkt met deze smart home-apps. Dit RF-apparaat kan ook naadloos worden geïntegreerd in de meest gangbare gebouwbeheersystemen, waaronder systemen met droge contacten.











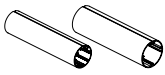
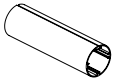

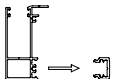









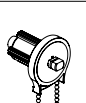



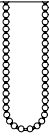



Scan voor
met uitleg



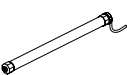
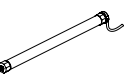
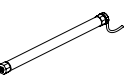







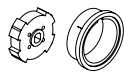













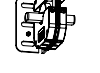
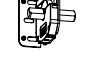





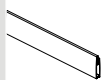

GEBOUWAUTOMATISERING / HOTEL AUTOMATISERING

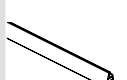





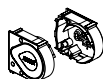

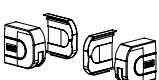



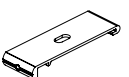



Door middel van relais aansturing kan de Atlantis® op ieder gebouwbesturingssysteem worden aangesloten. Standaard ook leverbaar met een Bi Directionale Bus controller, waardoor data feedback communicatie in bv. Crestron Automation applicaties mogelijk is.

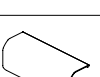

ATLANTIS OPEN	ATLANTIS GESLOTEN	SLIM LINE OPEN	SLIM LINE GESLOTEN	ARTIKEL	VERPAKKINGS- EENHEID		ART.NR
●	●			 RB ATLANTIS BUIS	5.8 mtr	50 mm 60 mm T5	0100058050 0100058060
●	●			 RB ATLANTIS BUIS EXTRA DIK 60MM T6	4.0 mtr 5.0 mtr	4.00 mtr breed systeem 4.00 mtr breed systeem	0100058060-4 0100058060-5
		●	●	 RB ATLANTIS SLIM LINE BUIS	58 mtr	5.80 mtr	0130058040
●	●			 RB ATLANTIS ZIJGELEIDINGSPROFIEL - IN DE DAG PLAATSING	5.8 mtr	wit zwart	0100078050 0100076050
●	●			 RB ATLANTIS ZIJGELEIDINGSPROFIEL - OP DE DAG PLAATSING	5.8 mtr	wit Bevestigingsprofiel	0110078580 0110078589
			●	 RB ATLANTIS SLIM LINE ZIJGELEIDING- SPROFIEL	5.8 mtr	achterzijde voorzijde	0130171580-B 0130171580-F
●	●			 RB ATLANTIS EINDKAP VOOR ZIJGELEIDINGSPROFIEL	50/doos	wit zwart	0100071000 0100076000
			●	 ATLANTIS SLIM LINE VERDUISTERENDE KAP VOOR ZIJGELEIDINGSPROFIEL	set, 20/doos	wit	0130071000 L&R
●	●			 RB ATLANTIS MOTOR ADAPTOR	5 set/doos	50 mm set universeel 60 mm set universeel	0100058055-S 0100058065-S
●	●			 RB ATLANTIS ASPROP	5/doos	50 mm 60 mm	0100058051 0100058061
●	●			 RB ATLANTIS ASPROP VERSTELBAAR	5/doos	50 mm 60 mm	0100058053 0100058064
●	●			 RB ATLANTIS VERBINDINGS ASPROP	5/doos	50 mm 60 mm	0100058052 0100058062
		●	●	 ATLANTIS SLIM LINE ASPROP	10/doos	wit grijs zwart	0130058065 0130058064 0130058063
		●	●	 ATLANTIS SLIM LINE KETTINGBEDIENING 1:1	5/doos	wit grijs zwart	0136001111 0136003111 0136006111
		●	●	 ATLANTIS SLIM LINE KETTINGBEDIENING 1:2	5/doos	grijs	0136351012 0136001012
●	●			 RB ATLANTIS KETTINGBEDIENING 1:2	1/doos	wit 50 mm wit 60 mm	0106001012 0106001013

ATLANTIS OPEN	ATLANTIS GESLOTEN	SLIM LINE OPEN	SLIM LINE GESLOTEN	ARTIKEL	VERPAKKINGS- EENHEID		ART.NR
●	●	●	●	 BS METALEN KETTING 6 MM RVS	100/doos	rol 150 mtr 1,50 mtr (eindeloos=0.75 mtr) 2,50 mtr (eindeloos=1.25 mtr) 3,00 mtr (eindeloos=1.50 mtr) 3,50 mtr (eindeloos=1.75 mtr) 4,00 mtr (eindeloos=2.00 mtr) 4,50 mtr (eindeloos=2.25 mtr)	3670008100 3670008150 3670008250 3670008300 3670008350 3670008400 3670008450
●	●	●	●	 BS KETTING 6 MM KUNSTSTOF WIT	100/doos	1,50 mtr (eindeloos=0,75 mtr) 2,00 mtr (eindeloos=1,00 mtr) 2,50 mtr (eindeloos=1,25 mtr) 3,00 mtr (eindeloos=1,50 mtr) 3,50 mtr (eindeloos=1,75 mtr) 4,00 mtr (eindeloos=2,00 mtr) 5,00 mtr (eindeloos=2,50 mtr) 6,00 mtr (eindeloos=3,00 mtr)	3670002150 3670002200 3670002250 3670002300 3670002350 3670002400 3670002500 3670002600
●	●	●	●	 DESIGN KOORD / KETTINGGEWICHT	10/doos	wit grijs zwart	3030701000 3030703000 3030706000
●	●	●	●	 VEILIGHEIDSCLIP VOOR KETTING Voor het bevestigen van de ketting aan de muur	25/doos	1 mtr	3645702000
		●	●	 ATLANTIS SLIM LINE STANGBEDIENING L OF R 1:2,5 WIT Kindveilige oplossing; gebruik in combinatie met Atlantis Slim Line aspropsteun	5/doos	rechts links	0136001000-R 0136001000-L
		●	●	 ATLANTIS SLIM LINE 12MM BEDIENINGS- STANG	5/doos	150 cm	0136011150
●	●			 FOREST TUBULAR BUISMOTOR Ø 35 MM	1/doos	230v/50hz 6nm/28rpm 230v/50hz 13nm/14rpm	3416600012 3416600016
●	●			 FOREST ULTRA STILLE BUISMOTOR Ø 35 MM	1/doos	230v/50hz 6nm/ 20rpm/sq	3416600017
●	●			 FOREST TUBULAR BUISMOTOR Ø 35 MM MET GEINTEGREERDE MULTI ONTVANGER	1/doos	230v/50hz 6nm/ 28 rpm 230v/50hz/ 13 nm/14 rpm	3416600112 3416600116
●	●			 FOREST ULTRA STILLE BUISMOTOR Ø 35 mm MET GEINTEGREERDE MULTI ONTVANGER	1/doos	230v/50hz 6nm/ 20 rpm/eq	3416600117
		●	●	 FOREST TUBULAR BUISMOTOR Ø 25 MM DOMOTICA	1/doos	tba	3416600119
		●	●	 FOREST TUBULAR BUISMOTOR Ø 25 MM MET GEINTEGREERDE MULTI ONTVANGER BEDRAAD	1/doos	230v/1.5/32	3416600118
●	●	●	●	 FOREST EASYTOUCH AFSTANDSBEDIENING 6 kanaals Voorzien van het originele RF protocol en Forest Link® protocol. Excl. Wandhouder	1/doos	mat wit mat zwart	5201081006 5201086006
●	●	●	●	 FOREST EASYTOUCH WANDHOUDER Alleen geschikt voor EasyTouch afstandsbediening. (binnenkort verkrijgbaar)	1/doos	transparant	5201080000
●	●	●	●	 FOREST DIAMOND SENSE AFSTANDSBEDIENING 2-15 kanaals met LED scherm Geïntegreerde timer modus Incl. magnetische wandhouder	1/doos	wit zwart	5201091470 5201086470
●	●	●	●	 FOREST DRAADLOZE WANDSCHAKELAAR 2 KANAALS LED	1/doos	wit zwart	5201001480 5201006480
●	●	●	●	 FOREST MULTI RECEIVER WAND- SCHAKELAAR Voor motor zonder geïntegreerde ontvanger	1/doos	8,5 x 8,5 x 3,5 cm	5104011500

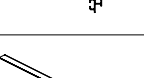
ATLANTIS OPEN	ATLANTIS GESLOTEN	SLIM LINE OPEN	SLIM LINE GESLOTEN	ARTIKEL	VERPAKKINGS- EENHEID	ART.NR
		●	●	 ATLANTIS SLIM-LINE DRIVE ADAPTOR SET Ø 35MM/MOTOR Ø 25MM	5/doos	0136600125
●	●			 RB ATLANTIS MOTOR ADAPTOR RING (ALLEEN VOOR SOMFY SONESSE)	5/doos	40 mm 0100058056
●				 RB ATLANTIS MOTORSTEUN VERSTELBAAR ENKEL RECHTS	5/doos	plafond rechts muur rechts 0100051010-CR 0100051010-WR
●				 RB ATLANTIS MOTORSTEUN VERSTELBAAR ENKEL LINKS	5/doos	plafond links muur links 0100051010-CL 0100051010-WL
●				 RB ATLANTIS MIDDEN MOTORSTEUN VERSTELBAAR DUBBEL	5/doos	0100051011
●				 RB ATLANTIS ASPROPSTEUN VERSTELBAAR ENKEL RECHTS	5/doos	0100051017-CR 0100051017-WR
●				 RB ATLANTIS ASPROPSTEUN VERSTELBAAR ENKEL LINKS	5/doos	0100051017-CL 0100051017-WL
●				 RB ATLANTIS ASPROPSTEUN VERSTELBAAR DUBBEL	5/doos	0100051018
●				 RB ATLANTIS ASPROPSTEUN VERSTELBAAR DUBBEL VOOR CASSETTE	5/doos	0100051019
●				 RB ATLANTIS KOPPELSTEUN VERSTELBAAR	5/doos	0100051020
●				 RB ATLANTIS KOPPELSTEUN VERSTELBAAR VOOR CASSETTE	5/doos	0100051021
	●			 RB ATLANTIS MOTORSTEUN VERSTELBAAR SMAL	5/doos	links rechts 0110051010-L 0110051010-R
	●			 RB ATLANTIS ASPROPSTEUN VERSTELBAAR SMAL	5/doos	links rechts 0110051017-L 0110051017-R
	●			 RB ATLANTIS ASPROPSTEUN VERSTELBAAR SMAL DUBBEL	5/doos	0110051019
	●			 RB ATLANTIS VERBINDINGSSTEUN VERSTEL- BAAR SMAL DUBBEL	5/doos	0110051021
	●			 RB ATLANTIS VERBINDINGSSTEUN VERSTEL- BAAR SMAL	5/doos	0110051023
	●			 MIDDEN MOTORSTEUN	5/doos	0110051011

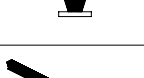
ATLANTIS OPEN	ATLANTIS GESLOTEN	SLIM LINE OPEN	SLIM LINE GESLOTEN	ARTIKEL	VERPAKKINGS- EENHEID		ART.NR
●	●			 RB ATLANTIS EINDKAP/RAND VOOR VERZWARINGSPROFIEL 9x40	50/doos	wit	0100061010
●	●			 RB ATLANTIS EINDKAP VLAK VOOR VERZWARINGSPROFIEL 9x40	50/doos	wit zwart	0100061000 0100066000
		●	●	 ATLANTIS SLIM LINE EINDKAP VOOR VERZWARINGSPROFIEL	100/doos	wit zilver antraciet	0130051000 0130051003 0130051005
●	●			 RB ATLANTIS BLOKKEER EINDKAP 9x40	10/doos	wit	0100071001
●	●			 RB ATLANTIS VERZWARINGSPROFIEL 9X40	5.80 mtr	wit zwart	0100068050 0100066580
●	●			 RB ATLANTIS GEWICHT VOOR VERZWARINGS-PROFIEL	1 mtr/doos	1 mtr	0100069100
		●	●	 ATLANTIS SLIM LINE VERZWARINGSPROFIEL 5.8MTR	58 mtr	wit zilver geanodiseerd zilver gepoedercoat antraciet	0130061600 0130063600 0130063600-PC 0130065600
		●	●	 ATLANTIS SLIM LINE VERZWARINGSPROFIEL 5x5MM		3 mtr	0130060300
●	●			 RB ATLANTIS SPANKABEL SET L/R	5 set/doos		0100090022
		●	●	 ATLANTIS SLIM LINE SPANKABEL SET L/R	1/stuk		0130090022
		●		 ATLANTIS SLIM LINE ASPROPSTEUN	5/doos	40 mm zilver	0130051017
		●		 ATLANTIS SLIM LINE MOTORSTEUN	5/doos	40 mm zilver	0130051010
		●		 ATLANTIS SLIM LINE IN DE DAG STEUN	10/doos	wit zilver zwart	0130041000 0130043000 0130046000
			●	 ATLANTIS SLIM LINE DARKENING EINDKAP L&R	set, 5/doos	wit	0130071001
●				 RB ATLANTIS EINDKAP L+R	10/doos	wit zwart	0100051000 0100056000
	●			 RB ATLANTIS EINDKAP SMAL KETTINGBEDIENING SET	10/doos	wit, links wit, rechts	0110071002-L 0110071002-R

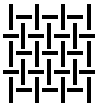
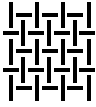
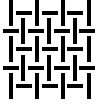
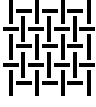
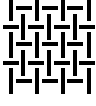
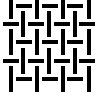
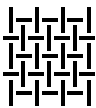
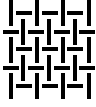
ATLANTIS OPEN	ATLANTIS GESLOTEN	SLIM LINE OPEN	SLIM LINE GESLOTEN	ARTIKEL	VERPAKKINGS- EENHEID		ART.NR
	●			 RB ATLANTIS EINDKAP SMAL LINKS/RECHTS	5 set/doos	wit zwart	0110055100 0110055600
		●		 ATLANTIS SLIM-LINE AFDEKKAP IN DE DAG STEUN	10/doos	wit zwart	0130041010 0130046010
			●	 ATLANTIS SL-D EINDKAP VERZWARINGSPROFIEL L&R	set, 20/doos	wit	0130081000
		●		 ATLANTIS SLIM LINE MONTAGESTEUN	25/doos	wit zilver geanodiseerd antraciet	0130051030 0130053030 0130055030
	●			 RB ATLANTIS SK STEUN cassette/muur/plafond	10/doos	wit zwart	0111630000 0111660000
	●			 RB ATLANTIS MONTAGESTEUN VOOR KOOF	10/doos	wit antraciet	0110051030 0110055030
			●	 ATLANTIS SLIM LINE MONTAGESTEUN	10/doos	wit antraciet	0130151000 0130155000
	●			 RB ATLANTIS MIDDENKAP SMAL	5/doos	wit	0110051001
●				 RB ATLANTIS MIDDENKAP	5/doos	wit	0100051001
●				 RB ATLANTIS AFDEKKAP	5.8 mtr	wit	0100098050
	●			 RB ATLANTIS CASSETTE AFDEKKAP SMAL	5.8 mtr	wit antraciet zwart	0110001580 0110005580 0110006580
			●	 ATLANTIS SLIM LINE AFDEKKAP	5.8 mtr	wit antraciet	0130101580 0130105580
	●			 RB ATLANTIS MONTAGEPROFIEL	5.8 mtr	wit antraciet zwart	0110058000 0110057000 0110056580
		●		 ATLANTIS SLIM LINE MONTAGEPROFIEL	58 mtr	5.80 mtr zilver geanodiseerd 5.80 mtr antraciet 5.80 mtr wit	0130053580 0130055580 0130051580
			●	 ATLANTIS SLIM LINE MONTAGEPROFIEL	58 mtr	5.80 mtr wit 5.80 mtr antraciet	0130151580 0130155580
●	●	●	●	 RB ATLANTIS ZELFKLEVENDE STRIP	10/bundel 58 mtr	8.5x1 mm 5.80 mtr wit	0100090001
			●	 ATLANTIS SLIM LINE AFSLUITPROFIEL ONDERZIJDE	set, 20/doos	5.80 mtr wit	0130181580
			●	 ATLANTIS SLIM LINE BORSTEL	600 mtr	5 mm	0130093600
●	●			 RB ATLANTIS BORSTEL VOOR ZIJGELEIDING/ BODEMPROFIEL	20 mtr/zak	8 mm zwart	0100096600

ATLANTIS OPEN	ATLANTIS GESLOTEN	SLIM LINE OPEN	SLIM LINE GESLOTEN	ARTIKEL	VERPAKKINGS- EENHEID	ART.NR
●	●	●	●	 FOREST SHADE 3% ROL BREEDTE 305 CM ROL LENGTE 40 M	1/rol	snow ivory grey haze dusty fawn charcoal rich black 0125011305 0125012305 0125013305 0125014305 0125015305 0125016305
●	●	●	●	 FOREST SHADE ALU 3% ROL BREEDTE 290 CM ROL LENGTE 40 M	1/rol	snow ivory grey haze dusty fawn charcoal rich black 0125021290 0125022290 0125023290 0125024290 0125025290 0125026290
●	●	●	●	 FOREST BLACKOUT ROL BREEDTE 305 CM ROL LENGTE 30 M	1/rol	snow ivory grey haze dusty fawn charcoal rich black 0125031305 0125032305 0125033305 0125034305 0125035305 0125036305
●	●	●	●	 FOREST ECO BLACKOUT ROL BREEDTE 310 CM ROL LENGTE 32 M	1/rol	snow cream grey haze perfect greige midnight black 0125041310 0125042310 0125043310 0125044310 0125046310
●	●	●	●	 FOREST MEDI BLACKOUT ROL BREEDTE 310 CM ROL LENGTE 32 M	1/rol	pure white canvas silver basalt olive grey charcoal 0125051310 0125052310 0125053310 0125054310 0125055310 0125056310
●	●	●	●	 FOREST ACOUSTIC DIMOUT ROL BREEDTE 240 CM ROL LENGTE 40 M	1/rol	snow ivory grey haze dusty fawn charcoal rich black 0125061240 0125062240 0125063240 0125064240 0125065240 0125066240
●	●	●	●	 FOREST SHADE FG 3% ROL BREEDTE 310 CM ROL LENGTE 30 M	1/rol	white white-linen white-pearl linen pearl black-grey black 0125071310 0125072310 0125073310 0125074310 0125075310 0125076310 0125077310
●	●	●	●	 FOREST SHADE FG 5% ROL BREEDTE 310 CM ROL LENGTE 30 M	1/rol	white white-linen white-pearl linen pearl black-grey black 0125081310 0125082310 0125083310 0125084310 0125085310 0125086310 0125087310
●	●	●	●	 ATLANTIS STOFFENWAAIER De stoffenwaaier is een handzame stalengids met informatie over de stoffen.	1/stuk	9901100050