



DOMOTICS
READY



APP
CONTROL



WIRELESS
REMOTE



CORDED
CONTROL

FOREST ROMAN BLIND Series

Elegantly shaped aluminium profile with integrated Velcro Tape

FOREST BS[®]
FOREST BS[®] MAX
FOREST BCS[®]

THE WORLD
BEHIND
YOUR
CURTAINS



FOREST BLIND SYSTEM - BS®



For a more streamlined look or when space is at a premium, roman blinds that stack neatly at the top of the window when retracted are the perfect solution. With the Blind System - BS® of Forest a sleek natural look is provided for your interior. Experience the simplicity of chain operation for Roman blinds. With an easy-to-use chain mechanism, adjusting the blinds to your desired position is effortless.

The Blind System - BS® is the most widely used and recognised roman blind in the industry. It comes with integrated velcro tape so that the fabric can be easily attached & removed. The system is always correctly alligned due to the twistlock on the cord roll support. For the ultimate convenience a motorised control option is possible. Operate the Blind System at the press of a button or by your smartphone. See for more info about motorised options check further down in this brochure.

PRODUCT INFORMATION

- Compact hand drawn roman blind system.
- For all types of light and medium weight draperies.
- Elegant shaped aluminium profile, with integrated Velcro hook tape.
- Application width: min. 38 cm & max 5.80 meter (19").
- Available height: 3.50 meter (11.5").
- Simple face-fix and top fix installation.
- Conic shaped drums; thus smooth and straight operation of the system is guaranteed.
- Self-braking endless chain control units.
 - 1:1 (fabric weight up to 3,5 kg)
 - 1:4 (fabric weight up to 7,5 kg)
- Total maximum fabric weight up to 7,5 kg.
- Colour available: white.
- Special Child Safety solution possible (1:4 & 1:4).
- Track finish: Aluminium powder coated.
- Warranty Manual System: 10 year.

FOR USE IN

Hotels, offices, residences, boats or anywhere an efficient Velcro track system for roman shades is required.

CONTROL OPTIONS





PROFILE

- Weight 409 gr/mtr
- Aluminium extrusion 6063 T5
- Size 33.3 x 36.7 mm (1.3" x 1.4")
- Colour available: white

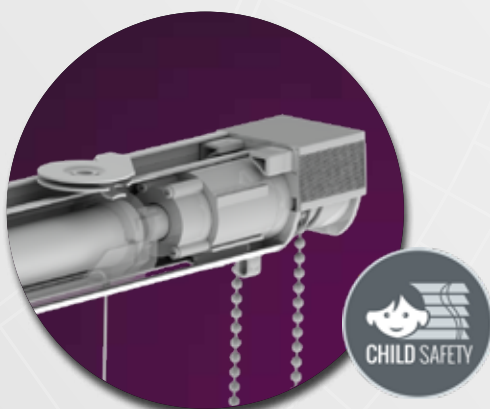
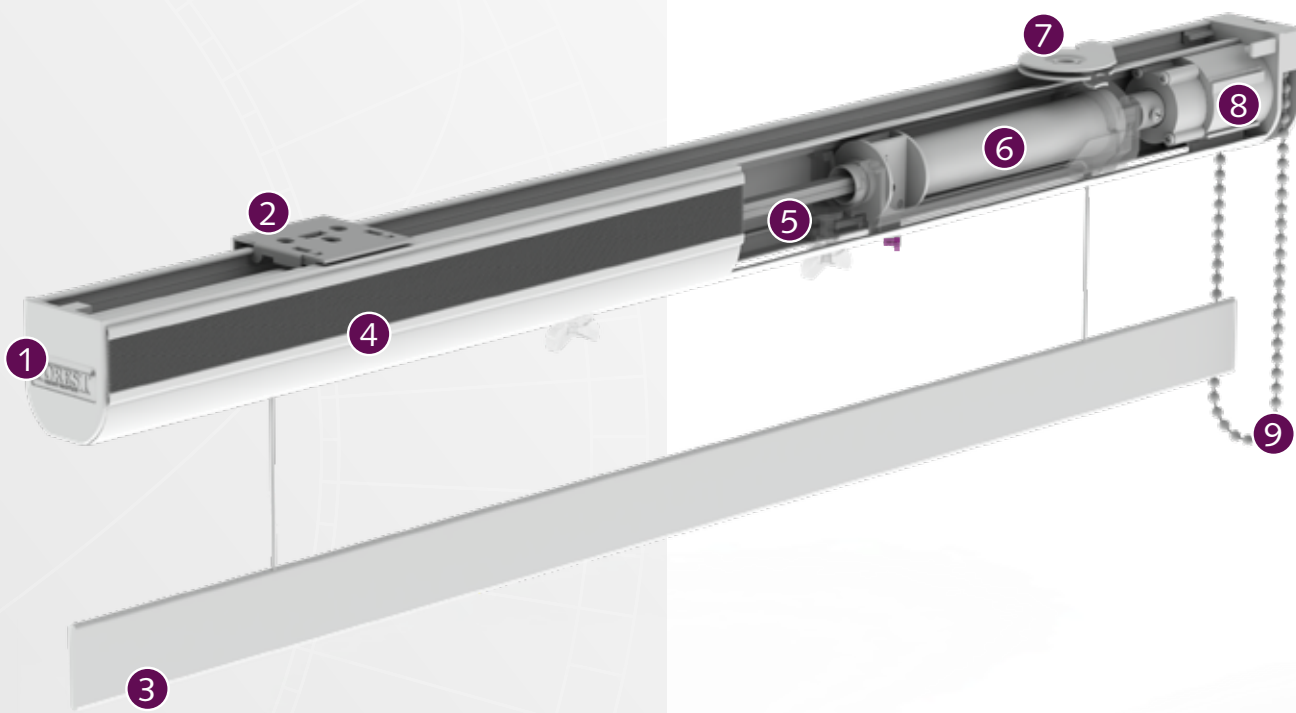
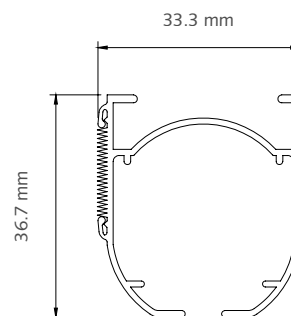

- ① BS Endcap
- ② BS Smart Klick® Ceiling / Wall Bracket
- ③ Counterweight bar 6 x 20 mm.
- ④ BS Track incl. Velcro Hook Tape
- ⑤ BS Rod 5x5mm
- ⑥ BS Quicklock Cord Roll
- ⑦ BS Ceiling bracket, swivel
- ⑧ BS Control Unit 1:4
- ⑨ Chain

FOREST BLIND SYSTEM MAX - BS MAX®



To complement the manual range of the roman blind systems for heavier duty drapery, Forest introduces the Blind System Max®.

The Forest BS Max® is developed for taller windows and heavier fabrics. This roman blind system can go up to a height of 4.80 meter with a total weight of 13 kg. It comes with integrated velcro tape so that the fabric can be easily attached & removed.

PRODUCT INFORMATION

- Hand drawn roman blind system.
- For all types of medium and heavy weight draperies.
- Elegant shaped aluminium profile, with integrated Velcro hook tape.
- Application width: min. 38 cm & max 5.80 meter (19").
- Available height: 4.80 meter (15,75").
- Simple face-fix and top fix installation.
- Cords are easy to remove; very useful when washing or dry cleaning the fabric.
- Self-braking endless chain control units.
- Maximum fabric weight per cord roll: 4 kg and total system 13 kg.
- Colour available: white.
- Track finish: aluminium powder coated.
- 10 year warranty

FOR USE IN

Hotels, offices, residences, boats, campers, planes or anywhere an efficient Velcro track system for roman shades is required.

CONTROL OPTION





PROFILE

- Weight 694 gr/mtr
- Aluminium extrusion 6063 T5
- Size 53.2 x 53.5 mm (2.0" x 2.1")
- Colour available: white

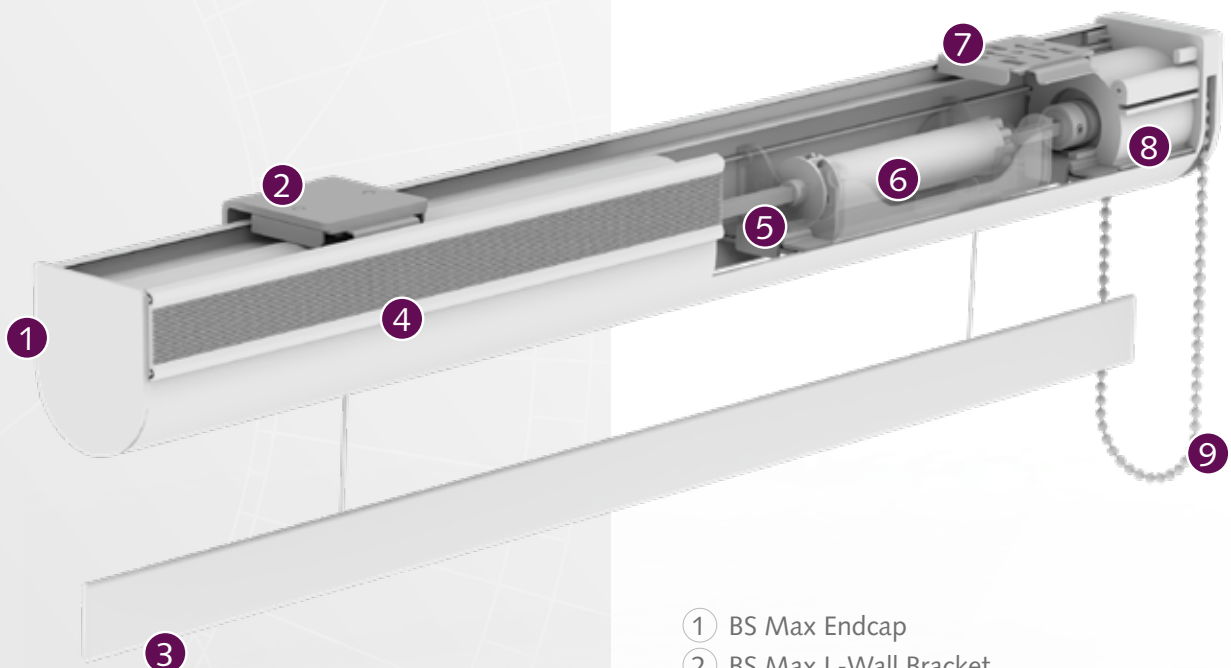
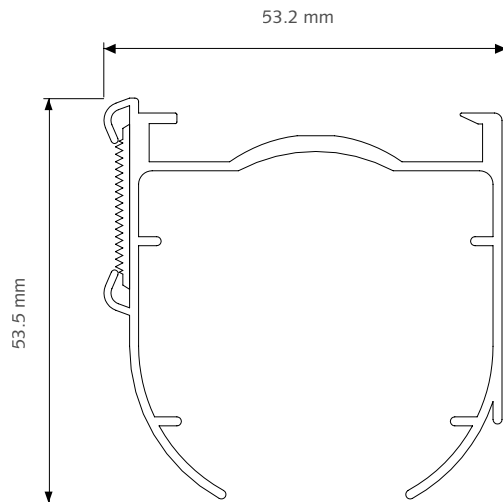

- 1 BS Max Endcap
- 2 BS Max L-Wall Bracket
- 3 Counterweight bar 6 x 20 mm.
- 4 BS Max Track incl. Velcro Hook Tape
- 5 BS Rod 5x5mm
- 6 BS Max Cord Drum
- 7 BS MaxHidden Ceiling Bracket
- 8 BS Max Control Unit 1:4
- 9 Chain

FOREST BLIND CONTRACT SYSTEM - BCS®



Another solution of Forest is the motorised roman blind 'BCS®-system', developed especially for taller window frames and heavier fabrics. The tubular motor in the system is 220 Volt and available in variable voltages as required. A powerful 121 Watt motor is standard, capable of lifting blinds of up to 13 kg; other motor types - capable of up to 26 kg - are available upon request. The cord coils can hold 5.5 meter of cord.

The Forest roman blind BCS® system is suitable for all current control systems and incorporates a unique, patented cord braking system. If, for any reason, the roll down action of a blind is obstructed, the motor automatically trips out to prevent the blind leaning and the cord breaking.

FOR USE IN

Domestic and/or project market, or at any location where a high quality and smooth operated motorized blind system is requested.

PRODUCT INFORMATION

- Motorised roman blind system.
- For all types of medium and heavy weight draperies.
- Elegantly shaped aluminium profile, with Velcro Hook Tape
- Available width: 5.80 meter (19").
- Application width: min. 65 cm & max 5.50 meter (18").
- Simple and quick installation with Smart Klick® bracket.
- Cords are easy to remove; very useful when you want to wash or dry cleaning the fabric.
- Can be controlled by wall switch, remote control (high frequency).
- Easy to connect to building automation systems.
- Easy to connect with third party Apps (Apple Homekit or Google Assistant) by the Forest Wireless Connector.
- Cord Drums can be placed on every position in the profile.
- Maximum fabric weight per cord roll: 4 kg.
- Tubular motor also available with internal Multi receiver and electronic limit setting.
- Track finish: aluminium powder coated.
- Warranty Manual System: 10 year.
- Warranty Motorised System: 5 year.

CONTROL OPTIONS





PROFILE

- Weight 1092 gr/mtr
- Aluminium extrusion 6063 TS
- Size 63 x 74 mm (2.4" x 2.9")
- Colour available: white

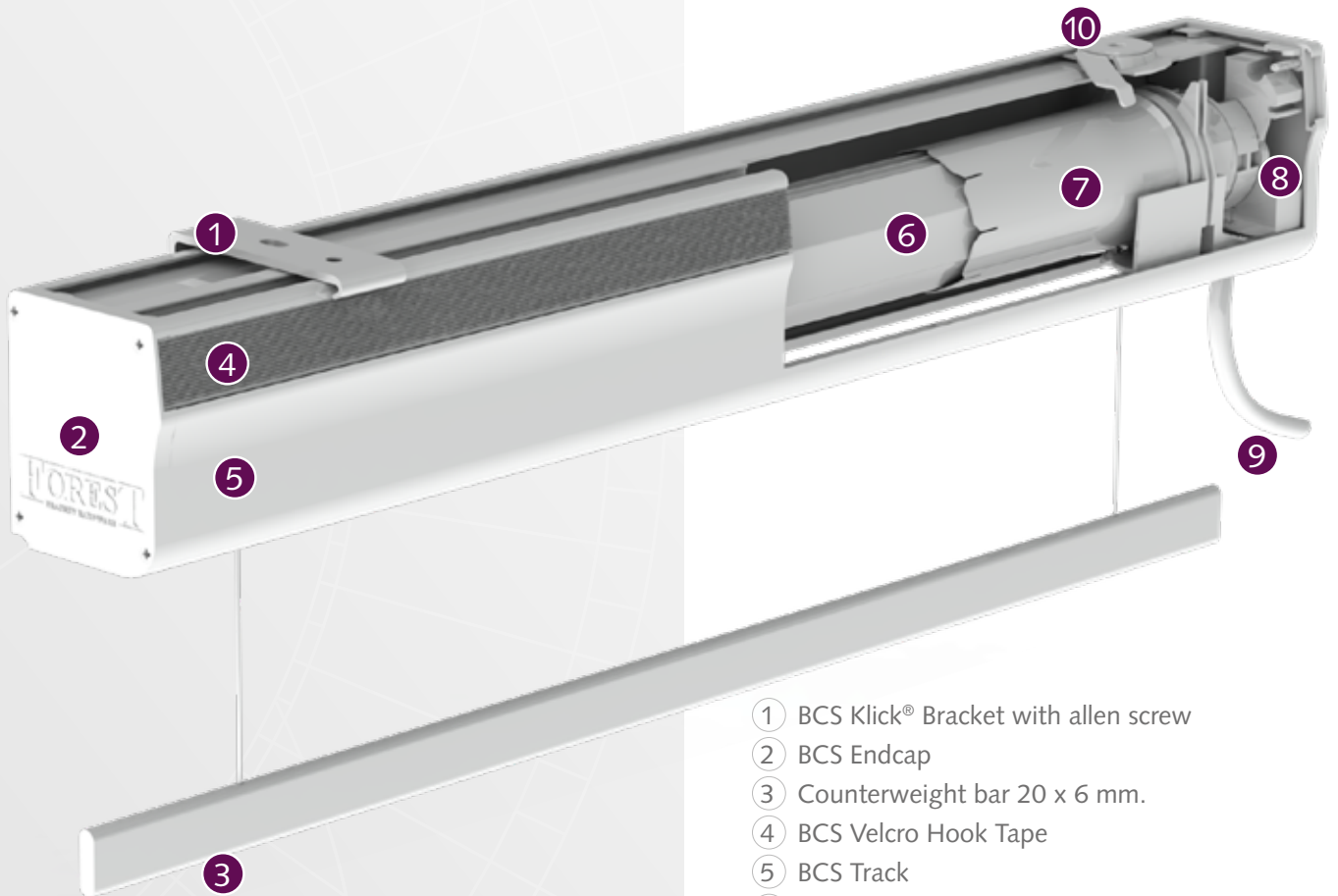
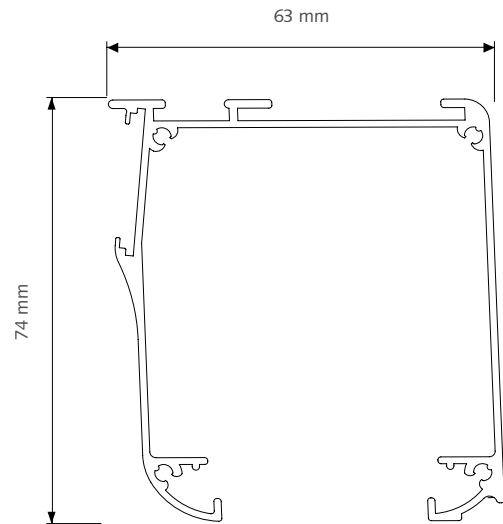

- 1 BCS Klick® Bracket with allen screw
- 2 BCS Endcap
- 3 Counterweight bar 20 x 6 mm.
- 4 BCS Velcro Hook Tape
- 5 BCS Track
- 6 BCS Tube 8-angular
- 7 BCS Cord Roll House Complete
- 8 BCS Centre Support
- 9 Forest Tubular Motor
- 10 Ceiling Swivel Bracket

FOREST BLIND CONTRACT SYSTEM - BCS®



SPECIFICATIONS

Type	Strength	Speed	Weightload	Noise level	Internal Receiver	Control options
6/28/S	6 Nm	28 rpm	13 kg	< 44 dB(A)	No	Home Automation / Forest Multi Receiver Wall Switch
6/20/SQ	6 Nm	20 rpm	13 kg	< 40 dB(A)	No	Home Automation / Forest Multi Receiver Wall Switch
13/14/S	13 Nm	14 rpm	26 kg	< 44 dB(A)	No	Home Automation / Forest Multi Receiver Wall Switch
6/28/E	6 Nm	28 rpm	13 kg	< 44 dB(A)	Yes	Forest Remote / Wireless Wall Switch / Forest Wireless Connector
6/20/EQ	6 Nm	20 rpm	13 kg	< 40 dB(A)	Yes	Forest Remote / Wireless Wall Switch / Forest Wireless Connector
13/14/E	13 Nm	14 rpm	26 kg	< 44 dB(A)	Yes	Forest Remote / Wireless Wall Switch / Forest Wireless Connector

MOUNTING

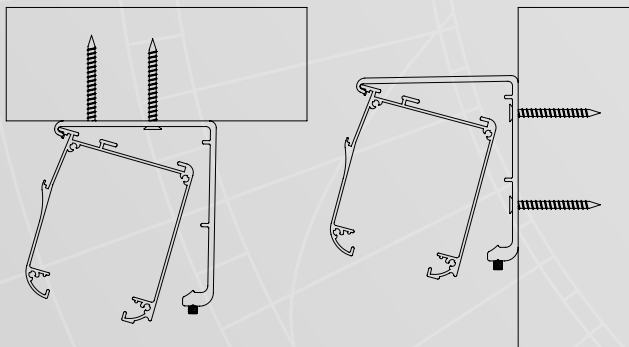

Wall and ceiling fixing is possible

ADJUSTING MOTOR

The limit settings for the tubular motors can be done as follows:

- S motors, mechanically by means of an allen key.
- E motors, electronically by means of a Forest Remote or RF Wall Switch.

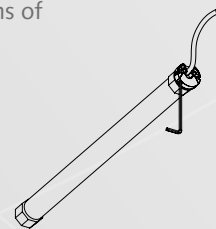



CONTROL OPTIONS

Our wide range of controls make finding a fit for your home even easier; controlling the curtains by hand, remote or even by building automation system. With the remote you can control the roman blinds in any position you like. Controlling the motorised roman blind system by your smartphone or tablet, you can create and schedule customised room scenes that allow your roman blinds to operate on their own throughout the day.

REMOTE CONTROL

We offer two types of RF remote controls: the EasyTouch and the Diamond Sense.

- The EasyTouch controls up to 6 systems, with the option to deactivate unused channels.
- The Diamond Sense is a 15- or 2-channel remote with an LED display. Systems can be operated manually or with the integrated timer. The LED display automatically lights up when your hand moves over it.

Both remotes have a range of up to 30 meters.



APP CONTROL VIA FOREST WIFI-DONGLE

With the Shuttle® Wi-Fi dongle, you can control your motorised roman blinds with your mobile device by the Forest Connect app or even by voice command with the easy integration in for example Google Home or Amazon Echo without the need for an additional hub or gateway.



APP CONTROL VIA FOREST WIRELESS CONNECTOR

The Forest Wireless Connector provides an easy solution to make Forest motorised roman blinds 'smart.' When combined with a smart plug, you can effortlessly control the curtains through a mobile app. Controlling the motorised roman blind system by your smartphone or tablet, you can create and schedule customized room scenes that allow your roman blinds to operate on their own throughout the day.



Scan for more info

If you prefer to use the Forest Connect App, you can opt for Forest's smart plug.

If you wish to operate your curtains with Apple HomeKit, Amazon Alexa, or Google Assistant, you will need a compatible third-party smart plug that works with these smart home apps. This RF device can also be seamlessly integrated into the most common building management systems, including systems with dry contacts.

BUILDING AUTOMATION / HOTEL CONTROL

The BCS® System can be connected to any Building Automation system, by relay control.



WORKS WITH





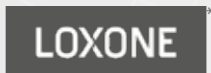





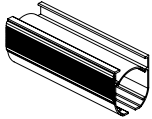



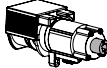
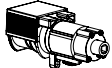

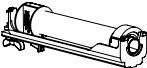
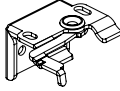
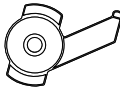
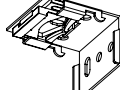
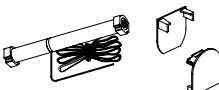
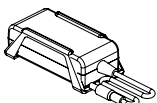
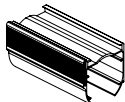

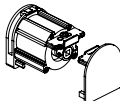
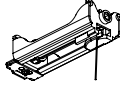
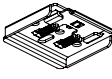

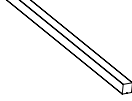
BUSCH-JAEGER

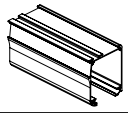

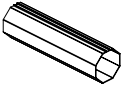
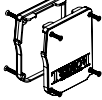
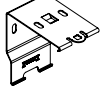
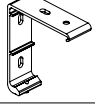
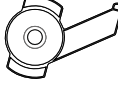
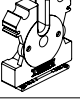

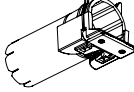
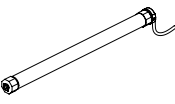
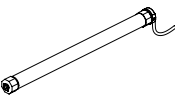
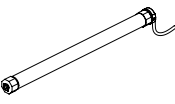
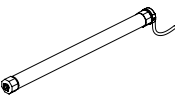

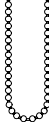



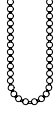

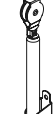





* Only works with actor.

Forest BCS® is compatible with many other Building Automation systems, thanks to its modular construction. A competitive advantage over other motorised drapery systems in the world!

BS	BS-MAX	BCS	ARTICLE	PACKING UNIT	ART.NR	
●			 <p>BS TRACK Extruded aluminium white powder coated, with Velcro hook tape on front of the track. Available length: 5.8 mtr. (19 Ft.)</p> 	58 mtr./bundle	white	3601001580
●			 <p>BS CONTROL UNIT 1:1, incl. endcap Weight capacity 3.5 kg</p>	100/box	white	3611001011-L
			 <p>BS CONTROL UNIT 1:4, incl. endcap Heavy duty, Self-braking. Operation by chain. Weight capacity 7.5 kg</p>	100/box	white	3611001014-L
●			 <p>CHILD SAFETY CONTROL UNIT 1:1 Child safe solution, incl. endcap Weight capacity 3,5 kg</p>	100/box	white	3611001011
			 <p>CHILD SAFETY CONTROL UNIT 1.4 Child safe solution, incl. endcap Weight capacity 7,5 kg</p> 	100/box	white	3611001000
●			 <p>QUICKLOCK CORD ROLL incl. 3.5 mtr. cord (different color types cord available upon request, see for colour options BS/BCS Cord)</p>	100/box	white/transparent	3642401350
						3642400000
●			 <p>BS WALL BRACKET, SWIVEL Metal</p>	100/box	white	3663001000
●			 <p>BS CEILING BRACKET, SWIVEL</p>	100/box	white	3661000000
●			 <p>BS SMART CLICK WALL / CEILING BRACKET Metal</p>	100/box	white	3662000000
●			 <p>BS MOTOR 24V Double shaft motor including 2 end caps and integrated-receiver.</p>	1/box		3648000000
●			 <p>FOREST ADAPTOR FOR BS MOTOR Forest adaptor with support bracket for BS motor (without cable)</p>	1/box	white	5232003002
				1/box	EU UK AUS USA	5201001101 5201001131 5201001141 5201001121
●			 <p>BS MAX TRACK Extruded aluminium white powder coated, with Velcro hook tape on front of the track Available length: 5,8 mtr (19 Ft.)</p> 	46,4 mtr./bundle	white	3710001580
●			 <p>BS MAX CONTROL UNIT 1:4 with endcap</p>	50/box	white	3711001014
●			 <p>BS MAX CORD DRUM incl. 4,8 mtr. cord</p>	50/box	white/transparent	3711000480
●			 <p>BS MAX HIDDEN CEILING BRACKET</p>	50/box	white	3711000000
●			 <p>BS MAX L-WALL BRACKET</p>	100/box	white	3711000001
●	●		 <p>BS ROD 5X5 MM ALUMINIUM Aluminium 5 x5 mm (0,20" x 0,20") Available length: 5,8 mtr (19 Ft.)</p>	10/bundle		3630000580
●	●	●	 <p>FIBEROD 6 meter length 4mm diameter</p>	600 mtr. / bundle		3535301600

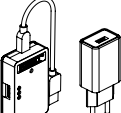
BS	BS-MAX	BCS	ARTICLE	PACKING UNIT	ART.NR
		●	 BCS TRACK Extruded aluminium white powder coated Available Length 5,80 mtr (19 Ft.)	500 mtr./roll	white 3416101000
		●	 BCS VELCRO HOOK TAPE 25 mm height. 1,20 meter length	1/box	white 3416500004
		●	 BCS TUBE 8-ANGULAR Length 5,80 mtr (19 Ft.)	1pc	white 3416102000
		●	 BCS ENDCAPS LEFT/RIGHT	25 sets/ box	white 3416201000
		●	 BCS EASY MOUNT WALL / CEILING BRACKET For wall and ceiling fixing.	25/box	white 3416301010
		●	 BCS MOUNTING BRACKET WITH ALLEN SCREW For wall and ceiling fixing.	25/box	white 3416301020-B
		●	 CEILING SWIVEL BRACKET For ceiling fixing.	100/box	white 3818200450
		●	 BCS CENTRE SUPPORT Dimension: 51 x 56 mm.	25/box	3416500000
		●	 BCS TUBE SUPPORT 8-ANGULAR To be placed on the open end of the 8 angular tube.	25/box	3416500003
		●	 BCS CORD DRUM COMPLETE Incl. 5.5 mtr white cord.	25/box	3416500002
		●	 FOREST TUBULAR MOTOR Ø 35MM 6/28/S 13/14/S	1/box	230v/50hz 6nm/28rpm 230v/50hz 13nm/14rpm 3416600012 3416600016
		●	 FOREST SILENT TUBULAR MOTOR Ø 35MM 6/20/SQ	1/box	230v/50hz 6nm/20rpm/SQ 3416600017
		●	 FOREST TUBULAR MOTOR Ø 35MM WITH INTERNAL RECEIVER 6/28/E 13/14/E	1/box	230v/50hz 6nm/28rpm 230v/50hz 13nm/14rpm 3416600112 3416600116
		●	 FOREST SILENT TUBULAR MOTOR Ø 35MM WITH INTERNAL RECEIVER 6/20/EQ	1/box	230v/50hz 6nm/20 rpm/EQ 3416600117
●	●	●	 COUNTER WEIGHT BAR 6 MTR	60 mtr./bundle 60 mtr./bundle 90 mtr./bundle 30 mtr./bundle	6 x 20 mm white 3 x 25 mm white 3 x 40 mm white 5 x 25 mm white 3501701600 3801400600 3801401600 3801402600
●	●	●	 ROMAN BLIND CHAIN 6 MM PITCH METAL STAINLESS STEEL	roll 1/bag	rol 150 mtr 1.50 mtr (drop=0.75 mtr) 2.00 mtr (drop=1.00 mtr) 2.50 mtr (drop=1.25 mtr) 3.00 mtr (drop=1.50 mtr) 3.50 mtr (drop=1.75 mtr) 4.00 mtr (drop=2.00 mtr) 4.50 mtr (drop=2.25 mtr) 3670008100 3670008150 3670008200 3670008250 3670008300 3670008350 3670008400 3670008450
●	●	●	 ROMAN BLIND CHAIN 6 MM PITCH METAL	roll 1/bag	rol 150 mtr 1.50 mtr (drop=0.75 mtr) 2.00 mtr (drop=1.00 mtr) 2.50 mtr (drop=1.25 mtr) 3.00 mtr (drop=1.50 mtr) 3.50 mtr (drop=1.75 mtr) 4.00 mtr (drop=2.00 mtr) 4.50 mtr (drop=2.25 mtr) 5.00 mtr (drop=2.50 mtr) 6.00 mtr (drop=3.00 mtr) 3670003100 3670007150 3670007200 3670007250 3670007300 3670007350 3670007400 3670007450 3670007500 3670007600

BS	BS-MAX	BCS	ARTICLE	PACKING UNIT		ART.NR
●	●		 ROMAN BLIND CHAIN 6 MM PITCH METAL MATT BLACK	roll	1.00 mtr	3670006100
●	●		 ROMAN BLIND ENDLESS CHAIN 6 MM PITCH PLASTIC WHITE	1/bag	1.00 mtr (drop=0,50 mtr) 1.50 mtr (drop=0.75 mtr) 2.00 mtr (drop=1.00 mtr) 2.50 mtr (drop=1.25 mtr) 3.00 mtr (drop=1.50 mtr) 3.50 mtr (drop=1.75 mtr) 4.00 mtr (drop=2.00 mtr) 4.50 mtr (drop=2.25 mtr) 5.00 mtr (drop=2.50 mtr) 6.00 mtr (drop=3.00 mtr)	3670002100 3670002150 3670002200 3670002250 3670002300 3670002350 3670002400 3670002450 3670002500 3670002600
●	●		 CHAIN JOINTING PLIER For joining two ends of the metal chain together	1/box		3675900001
●	●		 CORD/CHAIN WALL MOUNT SAFETY BOX SINGLE	25/box		3645702000
●	●		 TENSION PULLEY	25/box	white	1030501000
●	●		 CORD/CHAIN WEIGHT DESIGN	10/box	white grey black	3030701000 3030703000 3030706000
●	●	●	 LOOP TAPE 20MM To be fixed onto the curtain fabric	25 mtr./roll		3816202020
●	●	●	 ROMAN BLIND CORD For use in combination with Cord Roll Support / Cord Drum. Thickness: 1.3 mm.	500 mtr/roll	white (selection of 16 colours: White, corn, grey, off-white, brown, black, steel grey, old pink, mocca, beige, terra, moss, salmon, aubergine, green, pink)	3645001000
●	●	●	 SNAP CORD FIXER For easy adjustment of the bottom side of the blind	100/box	transparent	3647001001
●	●	●	 SNAP CORD FIXER CHILD SAFETY 	100/box	transparent	3611001001
●	●	●	 FOREST WIRELESS WALL SWITCH 2 CHANNEL LED	1/box	white black	5201001480 5201006480
●	●	●	 FOREST MULTI RECEIVER WALL SWITCH For motor without internal receiver	1/box	white	5104011500
●	●	●	 FOREST EASYTOUCH REMOTE CONTROL 6-channel Equipped with the original RF protocol and Forest Link® protocol. Excl. Wall holder	1/box	matt white matt black	5201081006 5201086006
●	●	●	 FOREST EASYTOUCH WALL HOLDER Only suitable for EasyTouch remote control (soon available)	1/box	transparent	5201080000
●	●	●	 FOREST DIAMOND SENSE REMOTE CONTROL 2-15 channel with LED display Integrated timer included Incl. magnetic wall holder	1/box	white black	5201091470 5201086470
●	●	●	 FOREST WIRELESS CONNECTOR Incl. 15cm USB cable excl. USB power plug One way transmitter to integrate system in Domotic System. To control by third apps like Google Home, Amazon Alexa or Apple Homekit use a (third-party) smart plug.	1/box	white USB power plug EU USB power plug UK USB power plug AU USB power plug US	5201002270 5201002271-EU 5201002271-UK 5201002272-AU 5201002274-US
●	●	●	 FOREST SMART PLUG WHITE The Forest Smart Plug allows App control via the Forest Connect App (the Forest Wireless Connector is required)	1/box	EU UK AU US	5201001952-EU 5201001953-UK 5201001954-AU 5201001955-US