

# FOREST<sup>®</sup>

DRAPERY HARDWARE

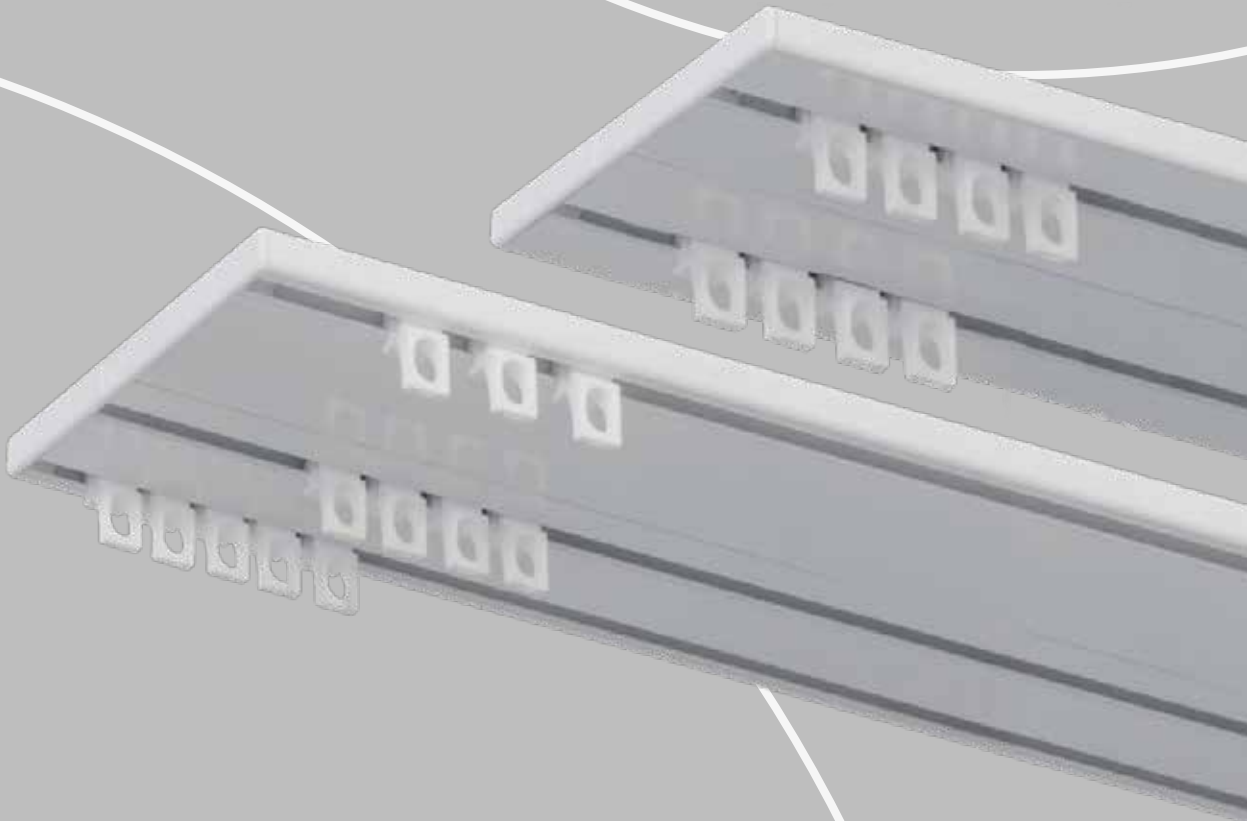

**MCS<sup>®</sup>**  
*Multi Channel System*

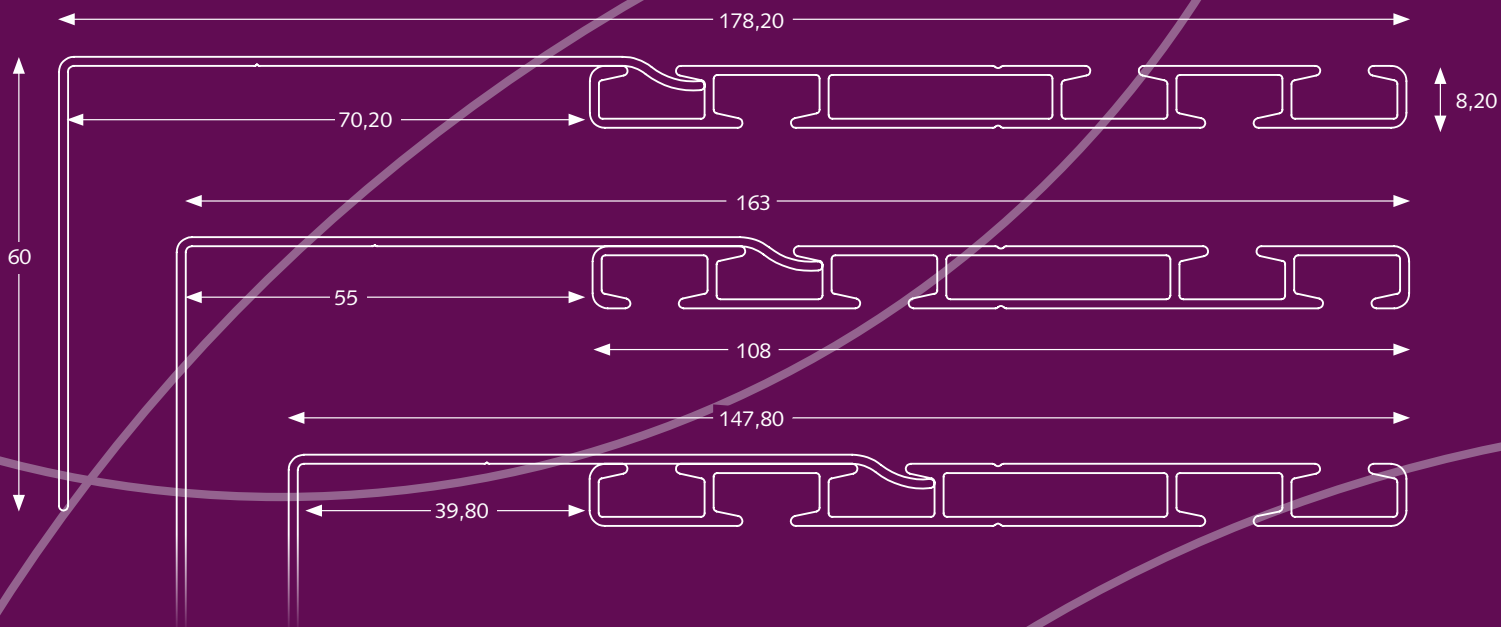

## MCS Track 2/3 Glide

### Product information

- Asymmetric Reversible Multi Channel System, for use as a 3 or 2 channel track.
- Profile thickness only 8 mm
- Easy installation thanks to 4,5 mm pre-drilled holes. For countersunk installation, 10mm cover caps also available. A profile version without pre-drilled holes is also available.
- Available in white, inox-pc and anthracite
- KS components can be used
- Maximum fabric weight 15 kg per running meter

## Profile

- Aluminium extrusion, powder coated, lubricated. Available in 6 meter length.
- One side of the profile has 3 channels, asymmetrically placed, to accommodate for a full sheer curtain, and two separate blackout curtains; these blackout curtains can overlap each other to prevent light leakage. The wider the fabric panels, the bigger the overlap will become.
- The other side of the profile has 2 channels, symmetrically placed, to accommodate for a sheer and blackout curtain in a traditional set-up. of track.

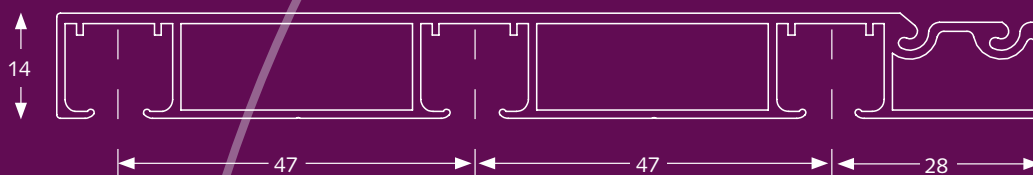

## MCS Track 3 glide

### Product information

- 3 glide Multi Channel track System;
- Easy installation thanks to pre-drilled holes;
- Sufficient spacing between the channels to allow for different pleating options;
- KS components can be used;
- Maximum fabric weight, 30 kg per running meter of track.
- Optional front cover cap available, for creating an easy pelmet cover.

## Profile

Aluminium extrusion, white powder coated, lubricated. Available in 4 and 5 meter length. Holes for fixing the track are pre-drilled every 50cm. Plastic cover caps for the fixing holes are available. The weight of the track is 1.14 kg/mtr.

## For use in

Hotels, offices, residences, boats, campers, planes or anywhere an efficient Multi Channel track System is required for curtains and drapes.



## MCS 2/3 Glide Pelmet Profile

A specially developed pelmet profile, aluminium extrusion, which can be placed on top of the MCS track during installation and secured in place. The perfect solution if no separate pelmet or curtain box has been foreseen.

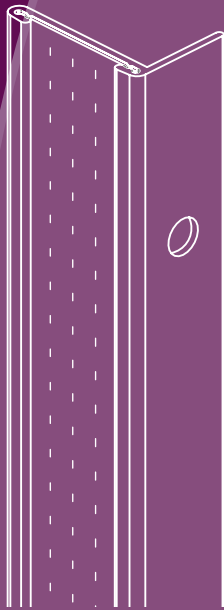

## Blackout Profile

The ideal solution to create a perfect blackout on the side of each curtain. The Velcro Hotel Profile is suitable for any Forest curtain rail system. The L shaped profile comes with pre-drilled holes every 50 cm, allowing for an easy fixation on the sides of the window. When the curtain hems are lined with Velcro loop tape, the curtain can be easily fixed against the profiles, eliminating light leakage.

## Draw Sticks

To complement the range of manually operated curtain track systems, Forest offers a wide range of draw sticks. By using a draw stick, a smooth operation and clean curtains are guaranteed. The draw sticks are finished with a stainless steel hook at the top, for easy fixation to the curtain track master carriers. Standard sizes: 92 cm, 122 cm and 152 cm.

Three versions are available:

- Fibreglass round
- Perspex hexagonal
- Aluminium extruded and hardened, finished with a cover cap at the bottom, hexagonal shaped and powder coated in four colour options, white (also 202cm available), inox-pc, anthracite-pc and antique-pc.

## Shape (cross cut, size in mm)

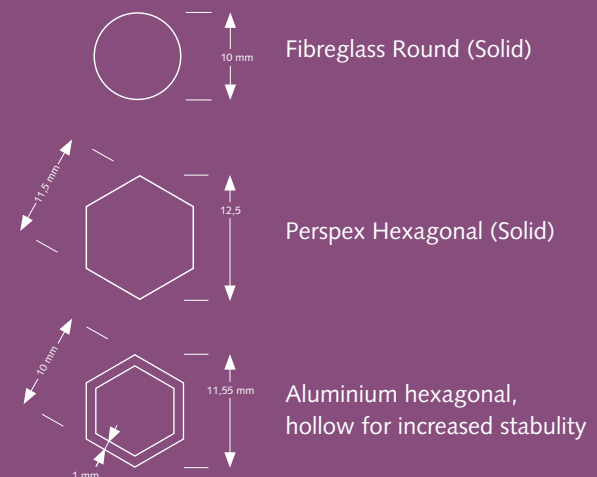

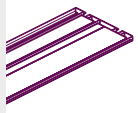

**MCS Track 2/3 Glide**  
6 Meter White  
6 Meter White - Predrilled

1/each  
5302021600  
5302021600-P



**Economy Carrier Small**

3910101000  
500/box



**MCS 2/3 Glide Pelmet Profile**  
Aluminium extrusion, white powder coated, profile can be locked into place at the top of the Multi Channel Track. Available in 6 meter length.

1/each  
5302031600



**CRS Carrier Round**  
Colours: 01, 03, 06.

58101..000  
500/box



**MCS 2/3 Glide Endcap**  
With screw White  
With screw Silver  
With screw Black

10/box  
5316101000  
5316103000  
5316106000

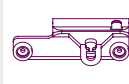

**Easyfold Mastercarrier Overlap Straight**  
The Plastic Master is reversible. There are also snaps on the back of the Mastercarrier.

4815101010  
25/box

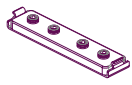

**MCS 2/3 Glide Connector**  
Straight - Steel

10/box  
5305200006

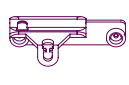

**Easyfold Mastercarrier Underlap**  
The Plastic Master is reversible. There are also snaps on the back of the Mastercarrier.

4815201010  
25/box

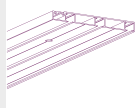

**MCS Track**  
Aluminium extrusion, white powder coated, lubricated. Available in 4 and 5 meter length.

20/bundle  
5301001400  
5301001500

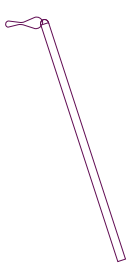

**Baton Fiberglass White** 1065101...  
092 cm (36"), 122 cm (48"), 152 cm (60"). 100/box

**Baton Transparant** 1065102...  
092 cm (36"), 122 cm (48"), 152 cm (60"). 50/box

**Baton Aluminium**  
092 cm (36"), 122 cm (48"), 152 cm (60").  
White 1065111...  
Silver 1065113...  
Black 1065116...  
Antique 1065119...  
50/box



**Velcro Hotel Profile**  
Inside frame fix, to reduce light leakage in combination with Looptape

3581601600  
120 mtr/bundle  
3816202020  
25 mtr/roll



**Carrier**  
"Clickable", offset, constructed of UV-resistant plastic. 10 Carriers on a break-away strip. Can be clicked in after installation.

1010001000  
500/box



**MCS Cover cap**  
MCS Cover caps 10mm white. The cap covers the screw hole and ensures a stylish and ultimate finished look.

500/box  
5399999999



**Twist End Stop**  
"Twists" into track, with metal plate, constructed of UV-resistant plastic.

1016201000  
100/box

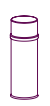

**Forest Lubricant**  
To lubricate components during assembly.

5109010000  
1/box

**FOREST**  
DRAPERY HARDWARE

