



**MANUAL**  
OPERATION



**RECESS**  
POSSIBLE



**EASY**  
TO BEND

## **FOREST KS**<sup>®</sup> *Klick System*

Highly efficient hand drawn system for all types of medium and light weight draperies.  
Quick installation with "Smart Klick" brackets for wall and ceiling applications.

**THE WORLD** *BEHIND*  
*your* **CURTAINS...**

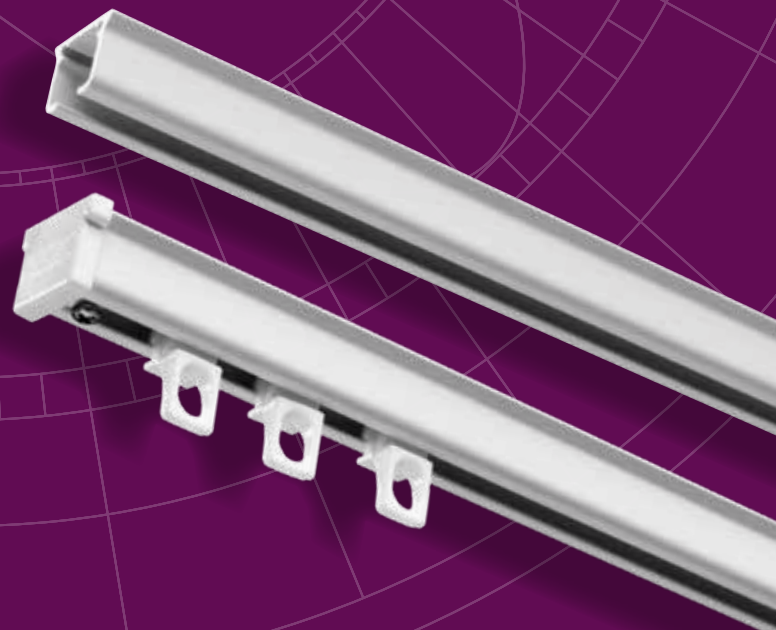

# FOREST KS®



## PRODUCT INFORMATION

- Highly efficient hand drawn system for all types of medium weight draperies.
- Quick installation with "Smart Klick" brackets for wall and ceiling applications with cover caps that conceal the screws.
- Bendable; it can be curved and reversed curved using a 10 cm (4") radius or continuous curve.
- Suitable for special window decoration as circular, arch and triangle window models.
- Heavy duty clickable carriers, UV-protected, for smooth and easy traversing.  
Offset shape for straight hanging pleats.
- Can also be used for Forest Easyfold System and accordiafold drapery systems.
- Maximum fabric weight: 8 kg per meter (6 LBS per ft.).
- Colours available: white, gold, silver, brown, black, cream, beige, red, blue, yellow and green.
- Special colours: available on request.
- Available lengths: 3 meter (9'10"), 4 meter (13'1"), 5 meter (16'4"), 6 meter (19'8"), 7 meter (23').
- Track finish: chromated powder coated with a factory applied patented dry lubricant.

## PROFILE

- Shown actual size 1:1.
- Aluminium Extrusion.
- Weight: 150 grams per meter (1.62 ounce per ft.).
- Dimensions: 14 mm x 20 mm (0,6" x 0,8").
- KS Recess: 12,5 mm x 21 mm (0,5" x 0,8")

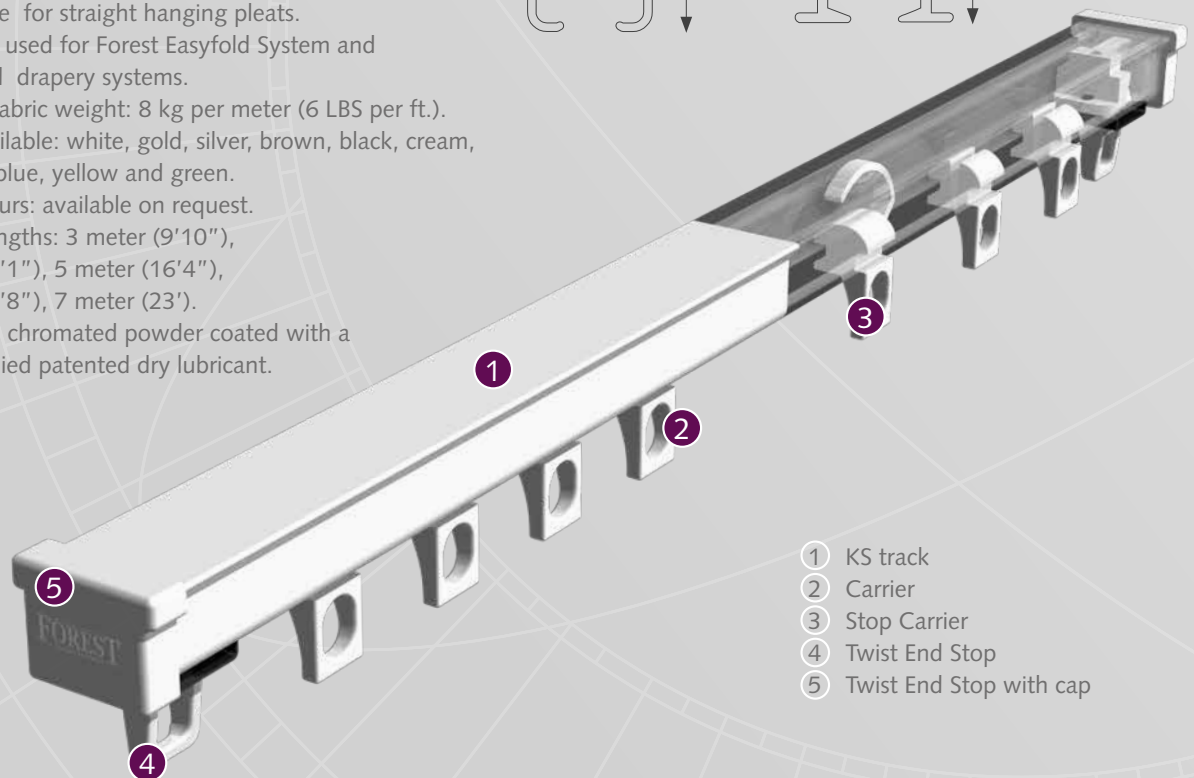
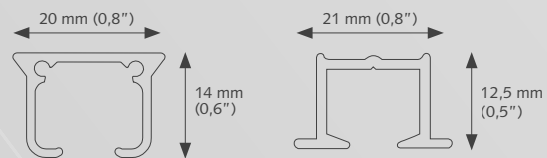

- 1 KS track
- 2 Carrier
- 3 Stop Carrier
- 4 Twist End Stop
- 5 Twist End Stop with cap



## FOR USE IN

Hotels - offices - schools - healthcare - residences - boats - campers - planes or at any location where an efficient hand drawn system is required.

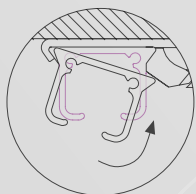

Easy installation  
click - position - tighten

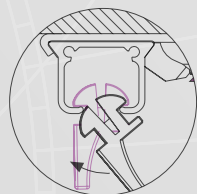

clickable carrier

25 mm (1")

## BENDING / CURVING

The track can be curved and reversed curved using a 10 cm (4") radius. Additionally there is a curving possibility for special windows like arches, bows and circles. Bending instructions available on request.



## SPECIAL WINDOW DECORATION

Special bends

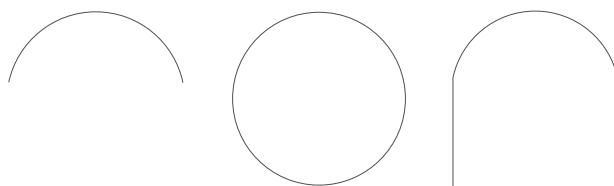

## APPLICATIONS

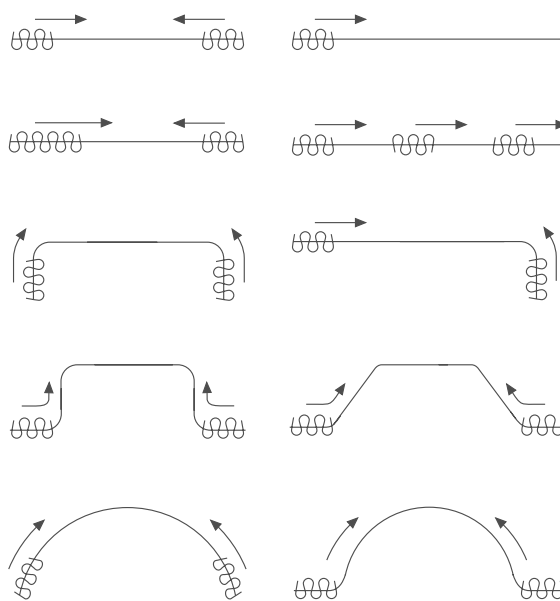

## MOUNTING BRACKETS

### Wall bracket

3,5 cm (1,4")

6 cm (2,4")

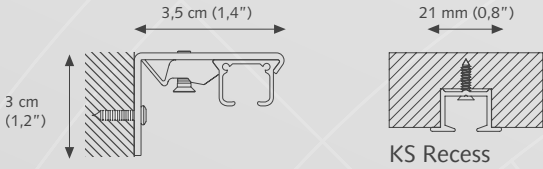

A) Min. 10 cm (4")



A) Min. 16 cm (6")

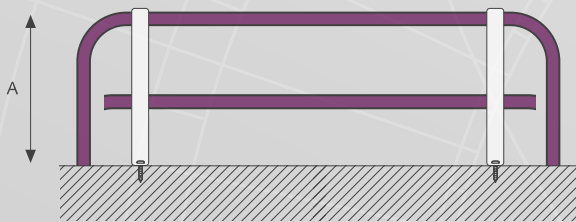

Other brackets are available. Brackets need to be placed every 60 cm (24").

### Smart Click Ceiling Bracket

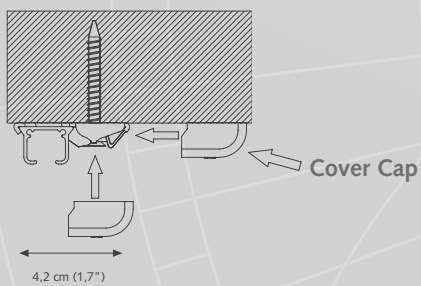

### Aluminium Wall bracket single

A) 7,5 cm (3") B) 6,3 cm (2,5")

A) 10 cm (4") B) 8,8 cm (3,5")

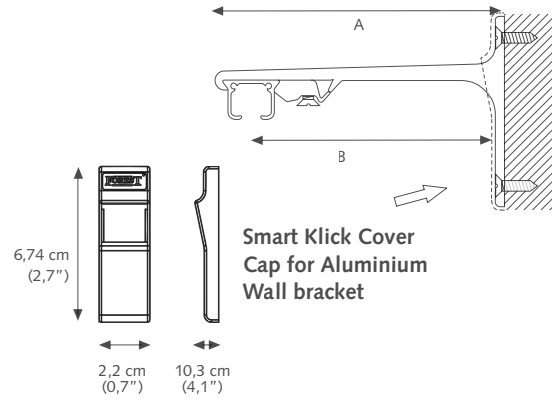

### Aluminium Wall bracket double

A) 15 cm (6") B) 9,2 cm (3,6") C) 4,5 cm (1,8")



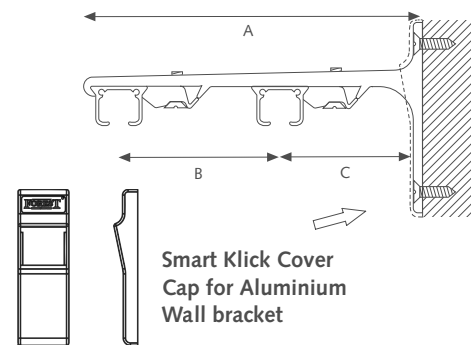



A) 20 cm (8") B) 9,2 cm (3,6") C) 9,5 cm (3,7")

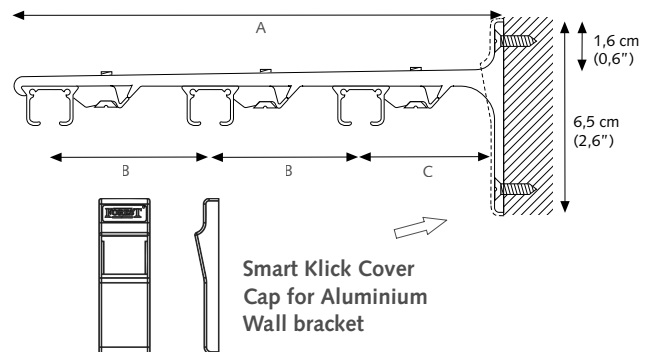

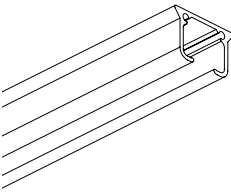
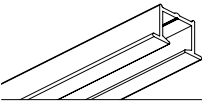
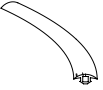
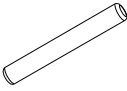
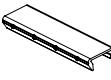
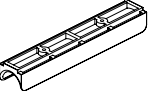
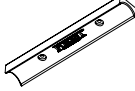





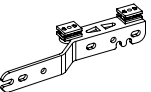

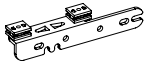
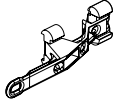
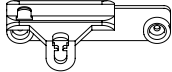
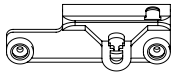
### Aluminium Wall bracket triple

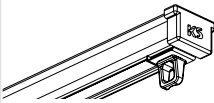
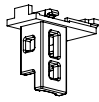

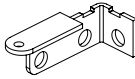
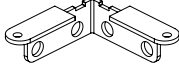
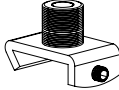

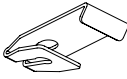
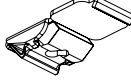
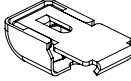

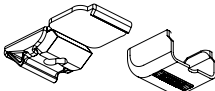
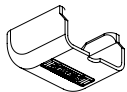
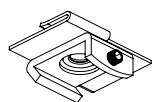
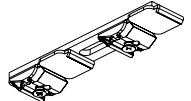
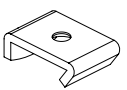
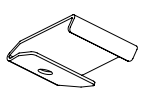
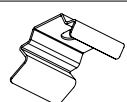
A) 25 cm (10") B) 9,3 cm (3,7") C) 5 cm (2")

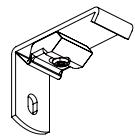
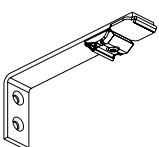
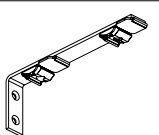
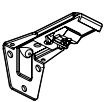
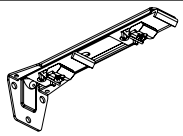

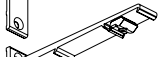
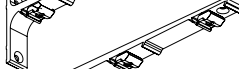
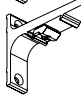
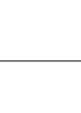
KS	KS RECESS	ARTICLE	PACKING UNIT	ART.NR				
●			KS TRACK WHITE Aluminium extrusion, powder coated, lubricated.	60 mtr/bundle 3 mtr (9'8") 80 mtr/bundle 4 mtr (13'1") 100 mtr/bundle 5 mtr (16'4") 120 mtr/bundle 6 mtr (19'8") 140 mtr/bundle 7 mtr (23')	1001001300 1001001400 1001001500 1001001600 1001001700			
			KS TRACK SILVER Aluminium extrusion, powder coated, lubricated.	80 mtr/bundle 4 mtr (13'1") 100 mtr/bundle 5 mtr (16'4") 120 mtr/bundle 6 mtr (19'8") 140 mtr/bundle 7 mtr (23')	1001003400 1001003500 1001003600 1001003700			
			KS TRACK BROWN Aluminium extrusion, powder coated, lubricated.	80 mtr/bundle 4 mtr (13'1") 100 mtr/bundle 5 mtr (16'4") 120 mtr/bundle 6 mtr (19'8") 140 mtr/bundle 7 mtr (23')	1001005400 1001005500 1001005600 1001005700			
			KS TRACK BLACK Aluminium extrusion, powder coated, lubricated.	100 mtr/bundle 5 mtr (16'4") 120 mtr/bundle 6 mtr (19'8")	1001006500 1001006600			
			KS TRACK Aluminium extrusion, powder coated, lubricated. off-white sand red blue yellow green	100 mtr/bundle 5 mtr (16'4") 5 mtr (16'4") 5 mtr (16'4") 5 mtr (16'4") 5 mtr (16'4") 5 mtr (16'4")	1001011500 1001012500 1001021500 1001022500 1001023500 1001024500			
			●	●		KS RECESS TRACK 6 Mtr (19'8") Aluminium extrusion, powder coated, lubricated and pre-drilled.	6 mtr/length white black	1031011600 1031016600
			●	●		MTS FLEXIBLE DUST STRIP. To seal the curtain track opening of the ks recess track during finishing phase.	100 mtr/roll	4518501000
			●	●		KS TRACK CONNECTOR IN STAINLESS 2X20 MM For a firm and seamless connection between two pieces of KS track.	10/box	9900000012
			●	●		KS/DS/CKS TRACK CONNECTOR	10/box white silver black	1018401010 1018403010 1018406010
			●	●		KS PLASTIC TRACK CONNECTOR Can be inserted in the track, but still allows the carrier to run over.	50/box	1018400000
			●	●		KS RECESS CONNECTOR		new 2020
			●	●		KS AS CARRIER "Klickable", offset, constructed of UV-resistant plastic. 10 Carriers on a break-away strip. Can be clicked in after installation.	500/box white silver brown black sand	1010001000 1010003000 1010005000 1010006000 1010012000
			●	●		KS SYMMETRICAL CARRIER	500/box white	1010101000
			●	●		KS STOPCARRIER Prevents slide back, "klickable", constructed of UV-resistant plastic.	250/box white silver black	1010201000 1010203000 1010206000
			●	●		KS SHIRRTAPE CARRIER Carrier and hook in one "klickable" unit, constructed of UV-resistant plastic. For sew on drapery tape.	500/box white silver brown black	1010401000 1010403000 1010405000 1010406000
●	●		KS AS CARRIER WITH METAL HOOK "Klickable", offset, with stainless steel hook, constructed of UV-resistant plastic. For use with grommets.	100/box white brown	1010501000 1010505000			
●	●		KS MASTER CARRIER METAL RIGHT OVERLAP Goes through curves, works with stiffeners and baton clips, can be corded, powder coated.	100/box white brown	1014101000 1014105000			

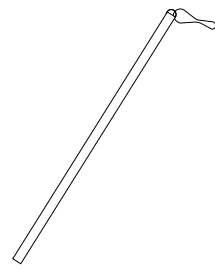
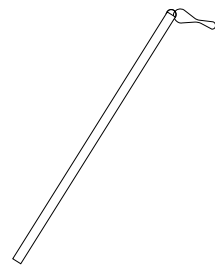
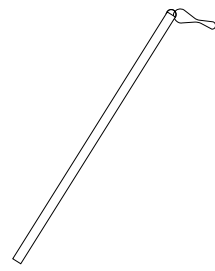
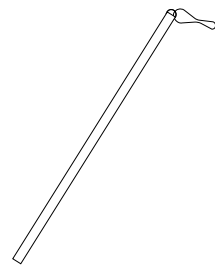
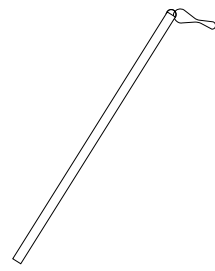
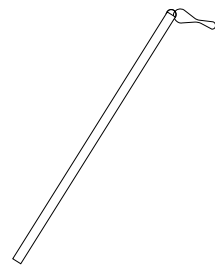
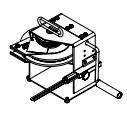
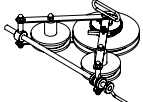
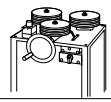
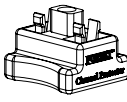
KS	KS RECESS	ARTICLE	PACKING UNIT		ART.NR
●	●	 <p>KS MASTER CARRIER METAL LEFT UNDERLAP Goes through curves, works with stiffeners and baton clips, can be corded, powder coated.</p>	100/box	white brown	1014401000 1014405000
●	●	 <p>MASTER CARRIER/REVERSIBLE Reversible overlap carrier, "Klicks" into track, constructed of UV-resistant plastic. For straight track only. Colours: 01.</p>	25/box		1010301000
●	●	 <p>EASYFOLD PLASTIC MASTER UNDERLAP The Plastic Master is reversible. There are also snaps on the back of the Master.</p>	25/box	white transparent silver black	4815201010 4815201000 4815203010 4815206010
●	●	 <p>EASYFOLD PLASTIC MASTER STRAIGHT The Plastic Master is reversible. There are also snaps on the back of the Master.</p>	25/box	white transparent silver black	4815101010 4815101000 4815103010 4815106010
●	●	 <p>KS TWIST ENDSTOP "Twists" into track, with metal plate, constructed of UV-resistant plastic.</p>	100/box	white silver	1016201000 1016203000
●		 <p>KS TWIST ENDSTOP WITH CAP "Twists" into track, with metal plate and end cap, constructed of UV-resistant plastic.</p>	100/box	white silver black	1016301000 1016303000 1016306000
	●	 <p>KS RECESS PUNCH ENDSTOP</p>			new 2020
●		 <p>KS ENDCAP + SCREW SHORT To be used for a single draw curtain.</p>	100/box	white silver black	1006001000 1006003000 1006006000
●		 <p>EASYFOLD KS UNIVERSAL ENDCAP WITH SCREW To be screwed with an Easyfold carrier, made of UV-resistant plastic.</p>	100/box	white silver brown black	4816001000-A 4816003000-A 4816005000 4816006000-A
●		 <p>KS WALL SUPPORT RIGHT 2,5 x 5 cm (1"x2") return plate, powder coated.</p> <p>KS WALL SUPPORT LEFT 2,5 x 5 cm (1"x2") return plate, powder coated.</p>	25/box	white silver	1016601000 1016603000
●		 <p>STRAIGHT RETURN R/L 5 x 5 cm (2 x 2") reversible return plate, powder coated.</p>	25/box	white brown	1016501000 1016505000
●		 <p>SUSPENSION BRACKET CLIP FOR MTS CEILING SUPPORT To be used in combination with the Suspension Ceiling Bracket</p>	50/box		1016901000
●		 <p>KS CEILING BRACKET Slides onto the track, powder coated. Regular duty.</p>	100/box	white silver brown black sand	1018001000 1018003000 1018005000 1018006000 1018012000
●		 <p>KS CEILING BRACKET WITH SLOT Slides onto the track, powder coated. Regular duty.</p>	100/box	white silver brown black off-white sand	1018101000 1018103000 1018105000 1018106000 1018111000 1018112000
●		 <p>KS SMART KLICK CEILING BRACKET "Klicks" onto track, powder coated.</p>	100/box	white silver brown black	1018201000 1018203000 1018205000 1018206000
●		 <p>KS SMART KLICK CEILING BRACKET + SLOT</p>	100/box	white	1018151000

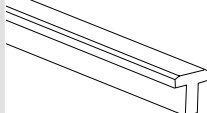
KS	KS RECESS	ARTICLE	PACKING UNIT		ART.NR
●		 <p>KS SMART KLICK CEILING BRACKET INCL COVER CAP "Klicks" onto track, powder coated.</p>	100/box	white silver brown black	1018201001 1018203001 1018205001 1018206001
●		 <p>KS SMART KLICK COVER CAP Fits on Smart Klick Wall and Ceiling bracket.</p>	100/box	white grey brown black	1019201000 1019203000 1019205000 1019206000
●		 <p>SUSPENDED CEILING BRACKET, METAL For installation on to a suspended ceiling. The track can be fixed in any angle.</p>	25/box		4519001000
●		 <p>KS SMART KLICK CEILING BRACKET DOUBLE LONG Distance between two tracks: 90 mm (3,5")</p> <p>KS SMART KLICK CEILING BRACKET DOUBLE SHORT</p>	30/box	white	1018601000  1018611000
●		 <p>FSS Mounting Bracket For concealed installation or ceiling installation in narrow spaces. Heavy Duty.</p>	100/box		7160001000
●		 <p>KS CEILING SPLICE BRACKET For ceiling installation only, powder coated.</p>	50/box	white silver brown black	1018501000 1018503000 1018505000 1018506000
●		 <p>KS Klick-On Ceiling Bracket White For concealed installation without visible brackets, light weight use only.</p>	100/box		1018301000
●		 <p>MTS Suspension Ceiling Bracket Length: 10 cm (4") - 1 m (3,3') 1 m (3,3') - 1,5 m (4,9')</p>	1/each		4518201000 4518201500
●		 <p>KS SMART KLICK WALL BRACKET 3,5 cm "Klicks" onto track, powder coated. One screw attachment. For light weight use only.</p> <p>KS SMART KLICK WALL BRACKET 6 cm "Klicks" onto track, powder coated. One screw attachment. For light weight use only.</p> <p>KS SMART KLICK WALL BRACKET 7,5 cm</p>	50/box	white silver black  white silver black  white silver black	1020201035 1020203035 1020206035  1020201060 1020203060 1020206060  1020201075 1020203075 1020206075
●		 <p>KS SMART KLICK WALL BRACKET 10 cm</p> <p>KS SMART KLICK WALL BRACKET 12,5 cm</p> <p>KS SMART KLICK WALL BRACKET 15 cm</p> <p>KS SMART KLICK WALL BRACKET 20 cm</p> <p>KS SMART KLICK WALL BRACKET 25 cm</p> <p>KS SMART KLICK WALL BRACKET 30 cm</p>	20/box 20/box 15/box 10/box 10/box 10/box	white silver white silver white silver white silver white silver	1020201100 1020203100 1020201125 1020203125 1020201150 1020203150 1020201200 1020203200 1020201250 1020203250 1020201300 1020203300
●		 <p>KS SMART KLICK WALL BRACKET DOUBLE For light weight use only.</p>	15/box	10 cm 15 cm 20 cm	1020601100 1020601150 1020601200
●		 <p>KS ADJUSTABLE WALL BRACKET, SINGLE</p>	100/box	white silver	1020801115 1020803115
●		 <p>KS ADJUSTABLE WALL BRACKET, DOUBLE</p>	50/box	white silver	1020801195 1020803195

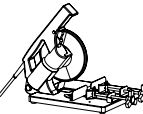
KS	KS RECESS	ARTICLE	PACKING UNIT		ART.NR
●		 KS SMART KLICK ALUMINIUM WALL BRACKET 7,5 cm	20/box	white silver	1020301075 1020303075
		 KS SMART KLICK ALUMINIUM WALL BRACKET 10 cm	20/box	brown black	1020305075 1020306075
		 KS SMART KLICK ALUMINIUM WALL BRACKET 15 cm	15/box	white silver	1020301100 1020303100
		 KS SMART KLICK ALUMINIUM WALL BRACKET 20 cm	15/box	black white	1020306100 1020301150
		 KS SMART KLICK ALUMINIUM WALL BRACKET 25 cm	10/box	silver brown black	1020303150 1020305150 1020306150
				white silver black	1020301200 1020303200 1020306200 1020301250 1020303250 1020305250
●		 COVER CAP FOR KS SMART KLICK ALUMINIUM WALL BRACKET	50/box	white silver black	1021301000 1021303000 1021306000
●	●	 KS FLICKSTICK FIBERGLASS	50/box	92 cm 122 cm	1065101092 1065101122
		 KS FLICKSTICK TRANSPARENT	50/box	152 cm 92 cm	1065101152 1065102092
		 KS FLICKSTICK WHITE ALUMINIUM	50/box	122 cm 152 cm	1065102122 1065102152
		 KS FLICKSTICK SILVER ALUMINIUM	50/box	92 CM 122 CM	1065111092 1065111122
		 KS FLICKSTICK BLACK ALUMINIUM	50/box	152 CM 92 CM	1065111152 106511202
		 KS FLICKSTICK ANTIQUE ALUMINIUM	50/box	202 CM 92 CM 122 CM	1065113092 1065113122 1065113152
				92 CM 122 CM 152 CM	1065116092 1065116122 1065116152 1065119092 1065119122 1065119152
●	●	 COMPACT BENDING TOOL For KS / KS RECESS / CKS	1/each		1050000000
					1050100000 1030000000
●		 CONTINUOUS CURVER Add on tool for the Compact Bending Tool. Designed to create continuous curves and arches in any radius. Includes KS bending strip. For KS and CKS Track only.	1/each		1060200000
●	●	 ELECTRIC POWERED BENDER Available in 230V or 115V To create continuous curves and arches minimum radius 50 cm (20")	1/each		1060500000
	●	 CHANNEL PROTECTOR with bit	1/set	purple	1070600000
	●	 KS RECESS PUNCH PINCHER	1/each		1060600000
●	●	 KS BENDING STRIP For Compact Bending Tool. KS RECESS BENDING STRIP Length of strip: 60 cm (23,6"). 2 strips	1/each 1/each		1060100000 8500000000-A 1030000000-D
			1/each		1060300000 8500000010
●	●	 KS/CKS BENDING WHEELS For Electric Powered Bender. Complete set of 3 wheels.	1/set		1060700000
●	●	 ELECTRIC POWERED RAILCUTTER 230 Volt EU	1/each		1061100000
					1061200000