

**MRS**<sup>®</sup>  
*Motorized Rod System*



**FOREST**<sup>®</sup>  
DRAPERY HARDWARE

## WEAR-RESISTANT PULLEY HOUSING



For a low-wear operation the pulley housing has been equipped with high-quality ball bearings.

## REINFORCED TRANSPORT BELT



The Kevlar reinforcement of the transport belt ensures a smooth and silent operation, which provides also for a long life-span.

## MOTOR



Two types of motors are available:

- 24V Forest Shuttle with touch impulse
- 230V FMS with 45 or 60 Watt

## REMOTE CONTROL



Easy opening and closing with the hand-held remote control.

### COMPLETELY CLOSED CURTAINS



The overlap carrier guarantees a complete closing of the curtains.

### EASY-RUNNING RETURN PULLEY



The special plastic of the return pulley's plain bearing ensures an easy running of the toothed belt.







### SELECT YOUR INDIVIDUAL FINIAL



Our large range of decorative finials offers you a great variety of design options. But it is also possible to use without a finial.

### HIGH-GRADE ALUMINIUM

We supply the special  $\varnothing$  28-mm rods with the following surfaces:

-  White
-  Inox-AN / Inox-PC
-  Anthracite-PC
-  Polished chrome
-  Taupe-PC
-  Antique Bronze
-  Gold





### SPECIFICATIONS TRACK

- Weight 480 gr / mtr
- Aluminium Extrusion
- Dimension 28 mm

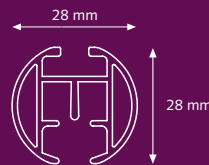

### FES<sup>®</sup> Forest Easyfold System

The Forest Easyfold System<sup>®</sup> is an additional feature of the drapery hardware systems of Forest Group. It complies fully with the contemporary demand for round and fluent shapes in decorative interiors. The easyfold system is also applicable on the MRS motorized rod system<sup>®</sup> and gives a modern and special folding design to the curtain, guaranteed to be a real eye-catcher in every room.

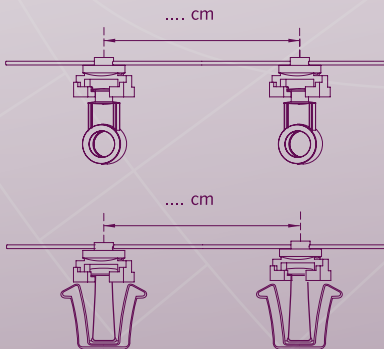

- 60%** = 8,0 cm carrier distance
- 80%** = 6,0 cm carrier distance
- 100%** = 5,4 cm carrier distance



Wave depth 10,75 cm or 15,75 cm with Easysnap tape and carriers. Ceiling space required 10,75 cm or 15,75.

Wave depth fully variable with Easyflex tape and carriers. Ceiling space required is equal to the spacing between the hook placement in the Easyflex tape.

**COLOUR CODES ARE AS FOLLOWS:**

01 White 02 Gold 03 Inox-AN 03 Inox-PC 04 Taupe-PC 05 Anthracite-PC 07 Chrome 08 Nickel 09 Antique Bronze-PC

**MRS FINIAL GEO-CONE WITH GROOVES**

Colour: black

5716106000  
2/box**MRS ENDCAP PEROSA**

Colours: 07, 08

57161..300  
2/boxnickel/chrome  
chrome/nickel5716110000  
5716110100**MRS FINIAL ROUND WITH GROOVES**

Colour: black

5716106100  
2/box**MRS ENDCAP BOLOGNA**

Colours: 07, 08

57161..400  
2/boxnickel/chrome  
chrome/nickel5716110200  
5716110300**MRS FINIAL CONE WITH GROOVES**

Colour: black

5716106200  
2/box**MRS ENDCAP PESCARA**

Colours: 07, 08

57161..500  
2/boxnickel/chrome  
chrome/nickel5716110400  
5716110500**MRS FINIAL HALF ROUND WITH GROOVES**

Colour: black

5716106300  
2/box**MRS ENDCAP MESSINA**

Colours: 07, 08

57161..600  
2/boxnickel/chrome  
chrome/nickel5716110600  
5716110700**MRS FINIAL ELLIPS WITH GROOVES**

Colour: black

5716106400  
2/box**MRS FINIAL CYLINDER SWAROVSKI**

GOLD CRISTAL

2/box

chrome  
nickel  
black5716111300  
5716111400  
5716111500**MRS ENDCAP RIVA**

Colours 07, 08

57161..000  
2/box**MRS FINIAL CYLINDER SWAROVSKI**

RED CRISTAL

2/box

chrome  
nickel  
black5716111600  
5716111700  
5716111800**MRS ENDCAP IMPERIA**

Colours: 07, 08

57161..100  
2/box**MRS FINIAL CYLINDER SWAROVSKI**

BLACK CRISTAL

2/box

chrome  
nickel  
black5716111000  
5716111100  
5716111200**ENDCAP ALLASIO**

Colours: 07, 08

57161..200  
2/box**MRS FINIAL ROUND**MADE OF CRISTALYZED  
SWAROVSKI5716111600  
2/boxOnly in combination with MRS Fitting:  
Colours: 06, 07, 08

57162..000

## MRS TRACK



	5.80 mtr:
WHITE	5701281580
GOLD	5701282580
INOX-AN	5701283580-AN
INOX-PC	5701283580-PC
TAUPE-PC	5701284580-PC
CHROME	5701287520
ANTHRACITE-PC	5701286580-PC
ANTIQUÉ BRONZE-PC	5701289580-PC

## MRS MOTOR PULLEY LEFT



WHITE	5730101000
GOLD	5730102000
TAUPE	5730104000-PC
ANTHRACITE - PC	5730106000-PC
CHROME	5730107000
INOX-AN	5730108000-AN
INOX-PC	5730108000-PC
ANTIQUÉ BRONZE	5730109000

## MRS MOTOR PULLEY RIGHT



WHITE	5730201000
GOLD	5730202000
TAUPE	5730204000-PC
ANTHRACITE - PC	5730206000-PC
CHROME	5730207000
INOX-AN	5730208000-AN
INOX-PC	5730208000-PC
ANTIQUÉ BRONZE	5730209000

## MRS RETURN PULLEY LEFT



WHITE	5730111000
GOLD	5730112000
TAUPE	5730114000-PC
ANTHRACITE - PC	5730116000-PC
CHROME	5730117000
INOX-AN	5730118000-AN
INOX-PC	5730118000-PC
ANTIQUÉ BRONZE	5730119000

## MRS RETURN PULLEY RIGHT



WHITE	5730121000
GOLD	5730122000
TAUPE	5730124000-PC
ANTHRACITE - PC	5730126000-PC
CHROME	5730127000
INOX-AN	5730128000-AN
INOX-PC	5730128000-PC
ANTIQUÉ BRONZE	5730129000

## CRS WALL BRACKET



Length: 12 cm	58161.028
	10/box
Colours: 01, 02, 03-AN, 03-PC, 04, 05, 09	

## CRS WALL BRACKET



Length: 16 cm	582012.28
	2/box
Colours: 01, 02, 03-AN, 03-PC, 04, 05, 09	

## CRS WALL BRACKET EXTENSION

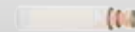

Length: 8 cm	58151..020
	2/box
Colours: 01, 02, 03-AN, 03-PC, 09	

## CRS ADJUSTABLE BRACKET EXTENDER



White	5815101070	10/box
Inox-AN	5815103070-AN	
Inox-PC	5815103070-PC	
Antique Bronze	5815109070-PC	

## CEILING SUSPENSION BRACKET



10 cm (4") bracket	58180.2028
Colours: 02, 03-AN, 03-PC, 05, 09	2/box

## CEILING SUSPENSION BRACKET



4 cm (1,6") bracket	58181.2000
Colours: 02, 03-AN, 03-PC, 05, 06	2/box

## RDS/MRS CONNECTOR



Connects the Master Carrier with the transport belt. 4805711500  
25/box

**COLOUR CODES ARE AS FOLLOWS:**

01 White 02 Gold 03 Inox-AN 03 Inox-PC 04 Taupe-PC 05 Anthracite-PC 07 Chrome 08 Nickel 09 Antique Bronze-PC

**MRS WALL BRACKET**

Length: 12 cm 57200..120  
2/box  
Colours: 07

**PLASTIC MASTERCARRIER RIGHT**

WITH BATON HOLDER 48151.010  
Colours: 01, 03, 06 2/box  
Transparent 4815201000

**MRS WALL BRACKET EXTENSION**

Length: 4 cm  
Colours: 07

**PLASTIC OVERLAPCARRIER LEFT**

WITH BATON HOLDER 48151.010  
Colour: 01, 03, 06 25pc/box  
Transparent 4815101000

**MRS WALL BRACKET EXTENSION**

Length: 8 cm 57151..080  
2/box  
Colours: 07

**MRS CARRIER ROUND**

Colours: 01, 03, 06 57101..00  
500/box

**MRS CEILING BRACKET**

Length: 1,5 cm 57184..050  
4/box  
Colours: 07

**FMS MASTER CARRIER UNDERLAP**

Multifunctional - arm is 15/box  
reversible for Click on stiffner  
White 5215801010  
Black 5215806010  
Silver 5215803010

**MRS CEILING BRACKET**

Length: 5 cm 57180..050  
4/box  
Colours: 02, 03-AN, 03-PC,  
07, 09

**FMS MASTER CARRIER OVERLAP**

Multifunctional - arm is 15/box  
reversible for Click on stiffner  
White 5215901010  
Black 5215906010  
Silver 5215903010

## CURTAIN MOTORS AND CONTROLS

For more information about the curtain motors and controls, see our FMS and Forest Shuttle brochures.

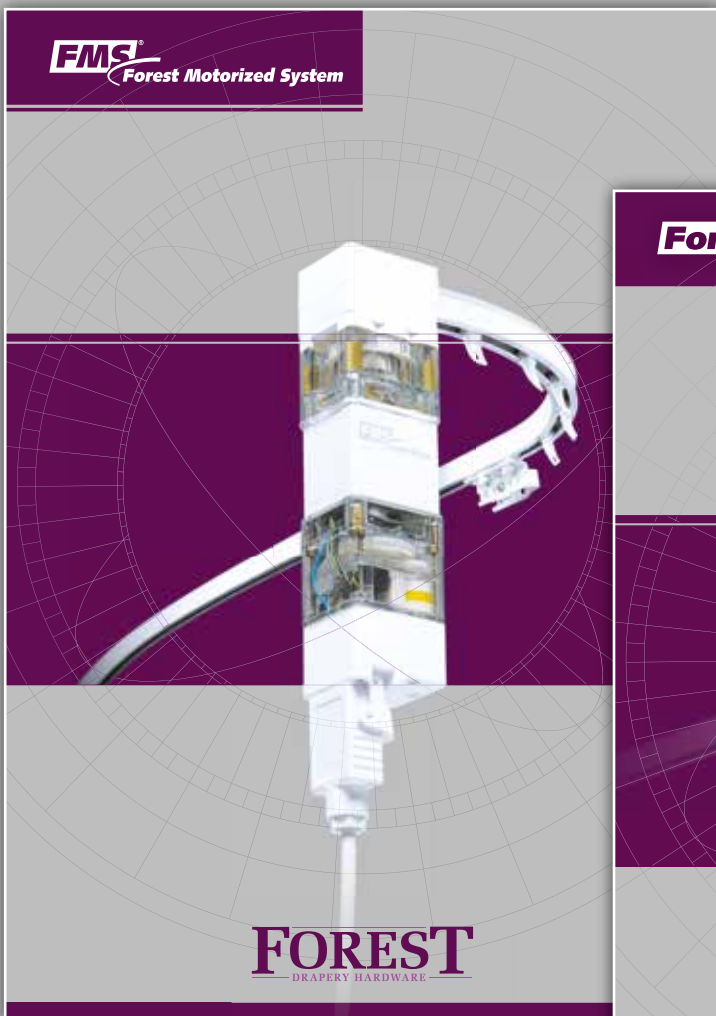

**FMS**  
Forest Motorized System

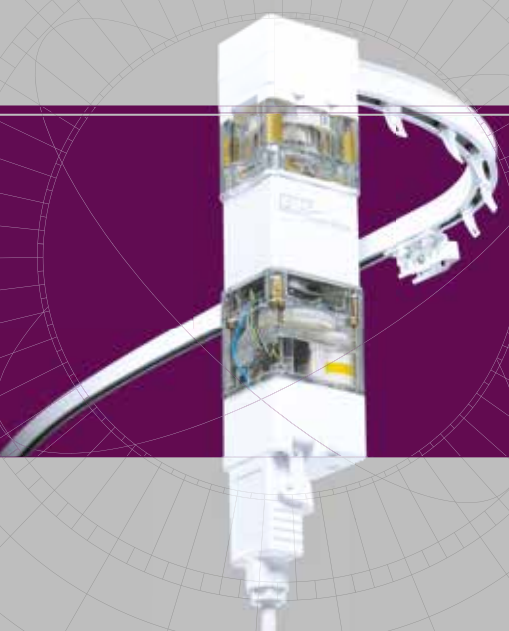

**FOREST**  
DRAPERY HARDWARE



**Forest Shuttle**

10 year WARRANTY

JUST A GENTLE TOUCH...



REMOTE CONTROL

SILENT TOUCH

OFFICE AUTOMATION

HOTEL AUTOMATION

HOME AUTOMATION

**FOREST**

FORESTGROUP.COM